

# Vixen®

## Instruction Manual for **MOBILE PORTA** Altazimuth Mount



## PREFACE

Thank you for your purchase of a Vixen "MOBILE PORTA" altazimuth mount with tripod.

- This manual describes the MOBILE PORTA with use of the A70Lf optical tube by way of example. You may occasionally find descriptions in the text not relevant to your model. If you purchase the product with a telescope optical tube as a complete package, be sure to read the instructions for your optical tube along with this manual.

**⚠ WARNING** Never look directly at the sun. Permanent and irreversible eye damage may result.

Never look directly at the sun with your naked eyes or with the telescope or its finder scope or eyepiece. Permanent and irreversible eye damage may result.

**⚠ CAUTION**

- ⊘ Avoid touching the mount and tripod while the MOBILE PORTA is being operated using the manual slow motion control handles, in the altitude and azimuth directions.
- ⊘ Do not leave the optical tube uncapped in the daytime.  
Sunlight passing through the telescope optical tube or finder scope may cause a fire.
- ⊘ Do not use the product while travelling or walking, as injuries may arise from stumbling, falling or collision with objects.
- ⊘ Keep small caps, plastic bags or plastic packing materials away from children. These may cause choking or suffocation.

## HANDLING AND STORAGE

- Do not leave the product inside a car in bright sunshine, or in hot places. Keep any strong heat radiation source away from the product.
- When cleaning, do not use strong solvent such as paint thinners or similar products.
- Do not expose the product to rain, water drops, dirt or sand.
- Blow off dust on lenses using a commercially available blower brush.
- Avoid touching any lens surfaces directly with your hands. In case a lens become dirty with fingerprints or general smears, gently wipe it using a commercially available lens cleaner and lens cleaning paper or cloth or consult your local Vixen dealer.
- For storage, keep the product in a dry place and do not expose to direct sunlight.

# TABLE OF CONTENTS

## BEFORE USE

◎Checking the Package Contents .....	P 4
◎What is an Altazimuth Mount? .....	P 4
◎Purpose of Using the Altazimuth Mount .....	P 4
◎Name of Each Component .....	P 5

## PREPARATION

◎Assembling the MOBILE PORTA Mount .....	P 6
I. Setting up the Tripod .....	P 6
II. Setting up the Multi-Arms .....	P 6
The Arm Lock Disc .....	P 7
Position Angle of the Multi-Arm .....	P 7
III. Attaching the Slow Motion Control Handles .....	P 7
Changing Tension of the Friction Stop Motion .....	P 8
Changing Position Angle of the Slow Motion Control Handles .....	P 8
1. Change the position of the dovetail mounting block to the altitude slow motion control handle. ...	P 8
2. Change the position of the optical tube to the azimuth slow motion control handle. ...	P 9
IV. Preparation for Mounting the Optical Tube .....	P10
V. Attaching the Optical Tube .....	P10
IV. Inserting an Eyepiece to the Visual Back .....	P11
Magnification of the Telescope .....	P11
VII. Attaching the Finder Scope .....	P12
VII-1 Attach the Finder Scope (MOBILE PORTA-A70Lf) .....	P12
VII-2 Attach the Finder Scope (MOBILE-PORTA-A62SS, MOBILE PORTA-VMC95L) ...	P12
VIII. Balancing the Optical Tube .....	P13
VIII-1 Balance an optical tube using tube rings. ....	P13
VIII-2 Balance an optical tube using a dovetail slide rail. ....	P13
◎Operating the MOBILE PORTA Mount .....	P14
I. Quick Slewing Motion .....	P14
II. Fine Motion and Tracking .....	P14
III. Viewing Terrestrial Landscape .....	P14
IV. Aligning the Finder Scope .....	P15
IV-1 Aligning the 6X24 Finder Scope on the A70Lf .....	P15
IV-2 Aligning the XY Red Dot Finder II on the VMC95L/A62SS .....	P16

## OBSERVATION

◎Observing the Moon .....	P17
---------------------------	-----

## APPLICATION

Accessories Chart for Photography .....	P18
-----------------------------------------	-----

## SPECIFICATIONS

MOBILE PORTA Mount .....	P19
MOBILE PORTA Telescope Packages .....	P19

# BEFORE USE

## ☉ Checking the Package Contents

The MOBILE PORTA altazimuth mount contains the items listed below. Check if all the items are included.

① MOBILE PORTA altazimuth mount with Tripod

② Allen wrench of 4mm on a side  
(For adjusting the tension  
of the friction stop motion.)

③ Allen wrench of 3mm on a side  
(For adjusting the position of  
the slow motion control handles.)

④ Slow motion  
control handles

⑤ Accessory tray



### The package consists of:

- ① MOBILE PORTA altazimuth mount with tripod
- ② 4mm Allen wrench
- ③ 3mm Allen wrench
- ④ Slow motion control handles
- ⑤ Accessory tray
- ⑥ Instruction manual (This book)



⑥ Instruction manual  
(This book)

※The specifications are subject to change without notice.

## ☉ What is an Altazimuth Mount?

An altazimuth mount features simple vertical and horizontal motion controls designed to easily point a telescope to the object you want to view.

## ☉ Purpose of Using the Altazimuth Mount

The altazimuth mounts can be assembled and handles easily. They are lightweight and easy to transport.

# BEFORE USE

## ◎ Name of Each Component

The contents of your MOBILE PORTA may differ when you purchase it as a mount package complete with an optical tube.

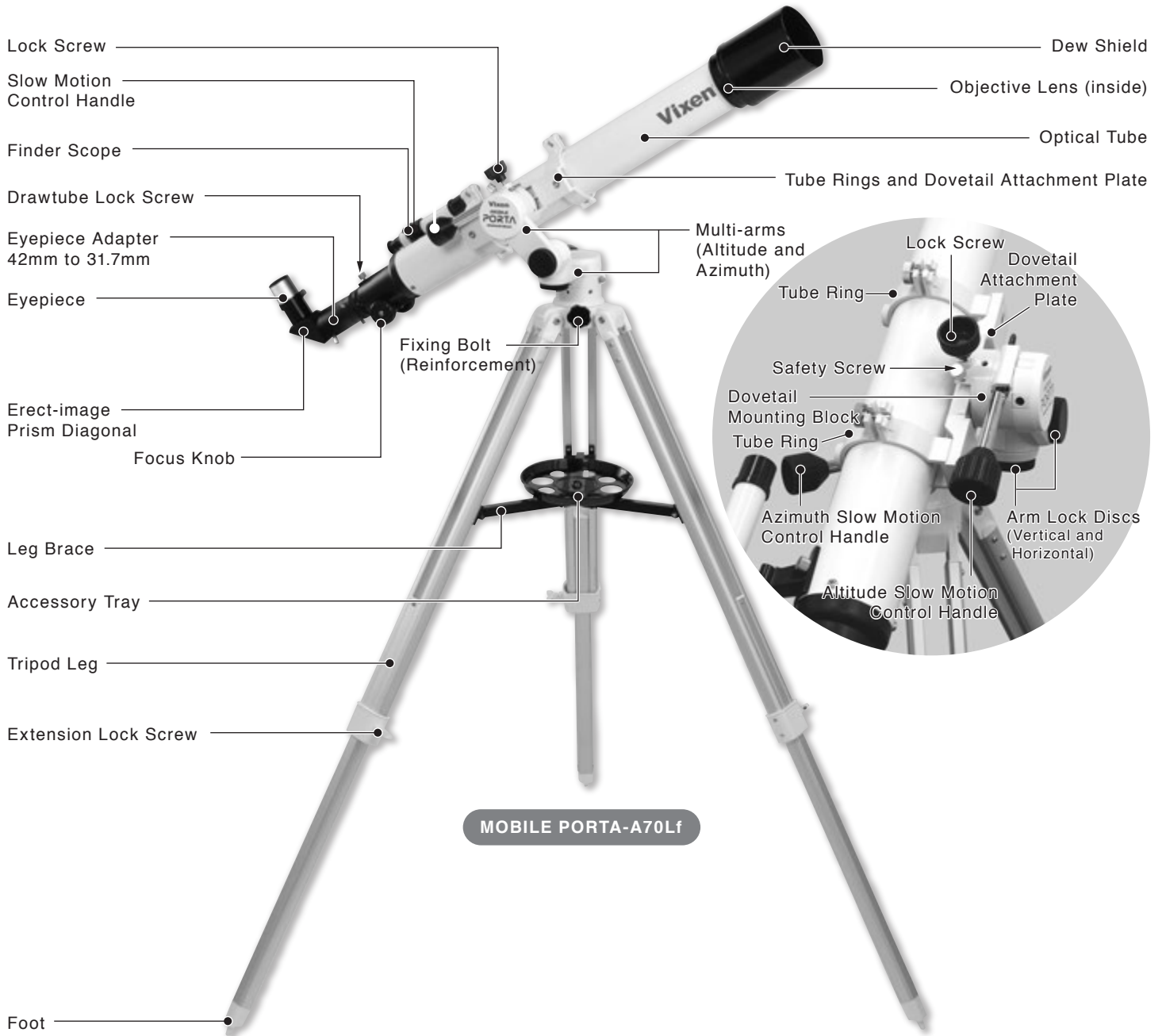

MOBILE PORTA-A70Lf

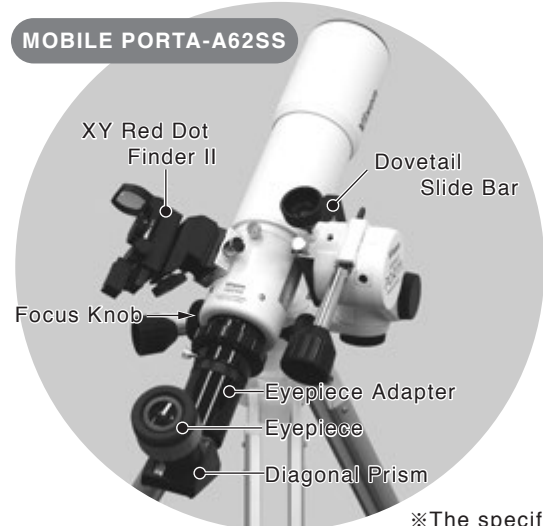

MOBILE PORTA-A62SS

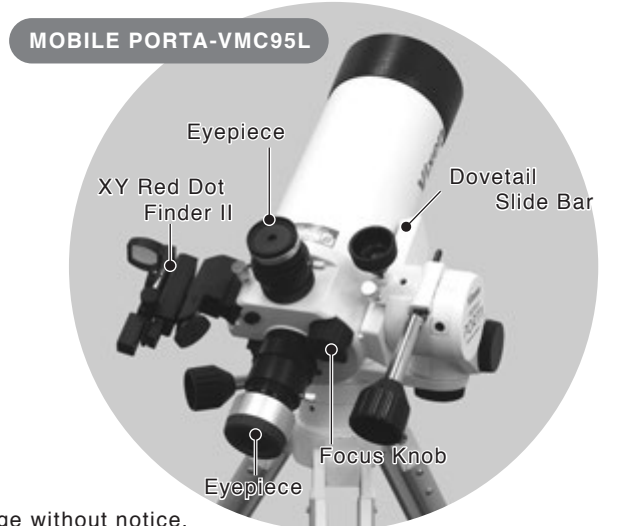

MOBILE PORTA-VMC95L

※The specifications are subject to change without notice.

# PREPARATION

## Assembling the MOBILE PORTA Mount

### I. Setting up the Tripod

- 1 Place the tripod on level and solid ground to ensure the telescope is stable during observation. Adjust the height of the tripod as the occasion demands.

To change the height, unfasten the extension lock screws on the tripod legs. Move the legs to the desired length.

After that, fasten the extension lock screws to hold the tripod legs securely in place.



- 2 Pull the tripod legs apart until the leg brace has been fully extended to let the tripod stand by itself

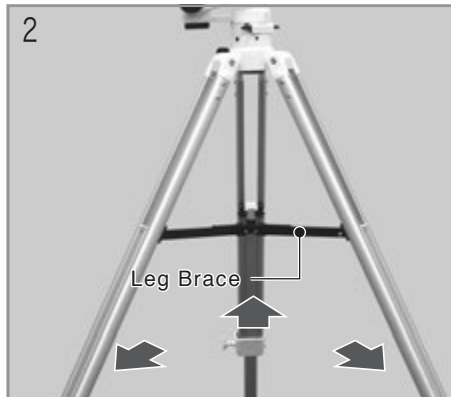

- 3 Place the accessory tray over the center of the leg brace and fix it in place by turning it.

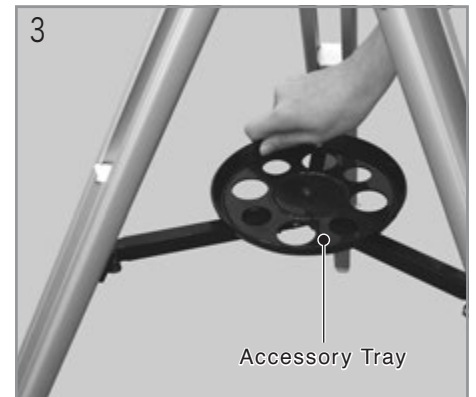

### II. Setting up the Multi-Arms (Moveable Single Fork Arm) The position angle of the multi-arms can be changed at intervals of 15 degrees.

- 1 While holding the altitude multi-arm, loosen the vertical arm lock disc to set the angle of the altitude multi-arm to your desired position.

Tighten the vertical arm lock disc securely after setting up the altitude multi-arm.

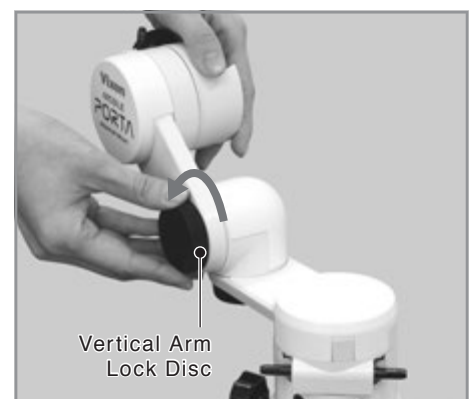

- 2 While holding the altitude multi-arm, loosen the horizontal arm lock disc to set up the orientation of the altitude multi-arm to your desired direction.

Tighten the horizontal arm lock disc securely after setting up the orientation of the altitude multi-arm.

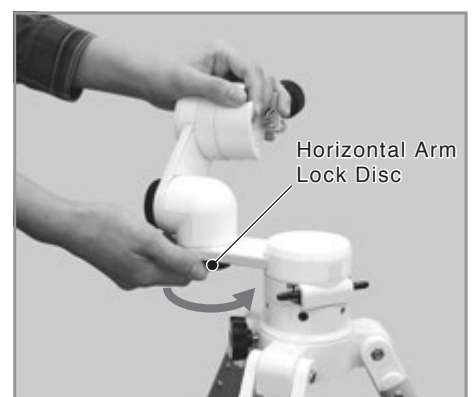

# PREPARATION

## The Arm Lock Disc

Make sure that the multi-arm is snug in the set position. If the multi-arm is locked in an unstable position, this may cause a sudden loosening of the multi-arm. This could damage the telescope or lead to injury.

### ■ Bad Example

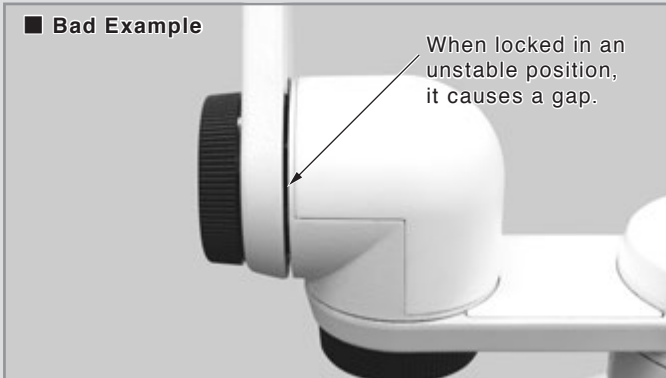

## Position Angle of the Multi-Arms

Check if the orientation of your telescope optical tube is restricted by the MOBILE PORTA mount. This should be done after you install the optical tube on the mount.

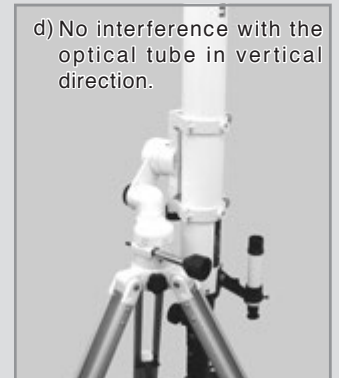
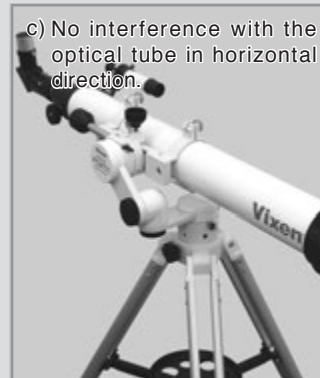
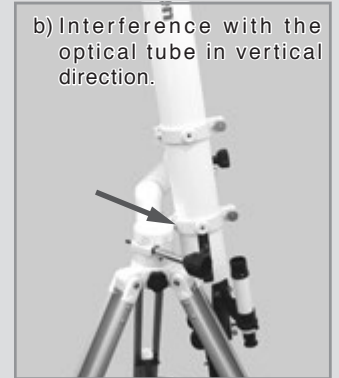
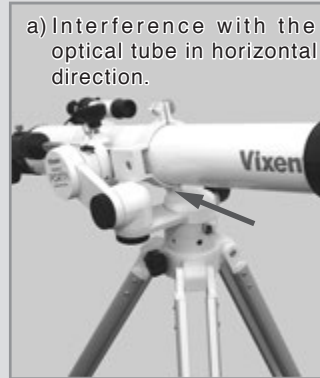

## III. Attaching the Slow Motion Control Handles

Attach the vertical and horizontal slow motion control handles onto each of the worm gear shafts. Orient the sleeve portion of the handle so that the dent on the sleeve goes to the flat portion of the worm gear shaft. Push it onto the worm gear shaft.

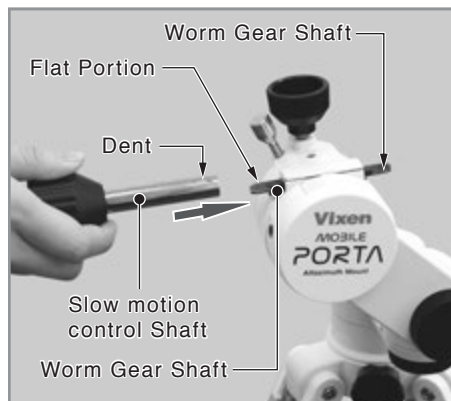
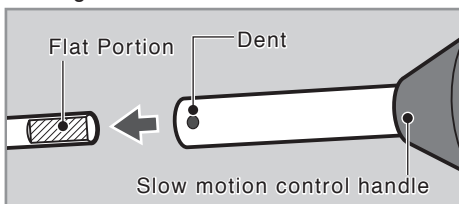

Note 1: There are two worm gear shafts, one on either side of the slow motion control unit. Use whichever one you find more convenient.

Note 2: The two slow motion control handles are the same and you can use whichever for vertical slow motion control or for horizontal slow motion control.

# PREPARATION

## III-1. Changing Tension of the Friction Stop Motion

One excellent feature on the MOBILE PORTA is the friction stop mechanism. The telescope optical tube moves as you guide it by hand, and stops as you release. However, you may need to adjust the tension of the friction stop motion in the altitude and azimuth directions if you install a somewhat heavy optical tube or optional accessory on the mount.

**Adjust the tension of the friction stop motion by loosening or tightening the tension adjustment screws with the supplied 4mm Allen wrench.**

It is not necessary to tighten the tension adjustment screws completely. It may cause too much resistance and can lead to a malfunction. Hold the optical tube firmly while loosening the tension adjustment screws as this may affect the balance.

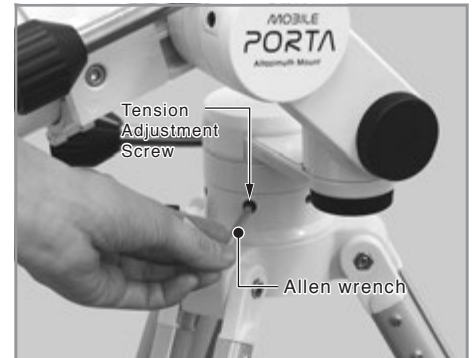
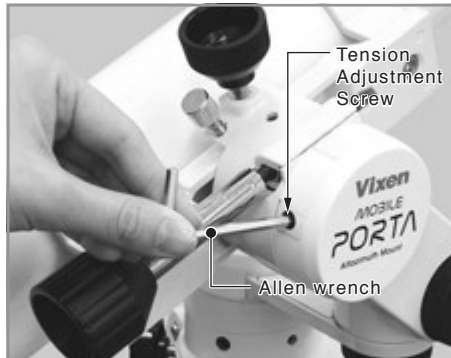

## III-2. Changing Position Angle of the Slow Motion Control Handles

The position angle of the slow motion control handles related to the dovetail mounting block and to the optical tube can be changed at an interval of 15 degrees as the need arises.

### 1. Change the position of the dovetail mounting block to the altitude slow motion control handle.

**1** Remove the optical tube from the dovetail mounting block for safety. While holding the optical tube in the horizontal position, loosen the safety screw first, and then, loosen the lock screw to remove the optical tube. Remove the lock screw to avoid interference with the altitude slow motion control handles.

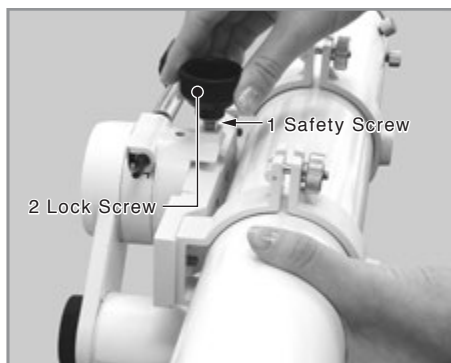

**2** There are three hex socket screws on the side of the dovetail mounting block. Loosen each of the screws with the 3mm Allen wrench. (Do not loosen these screws too much.)

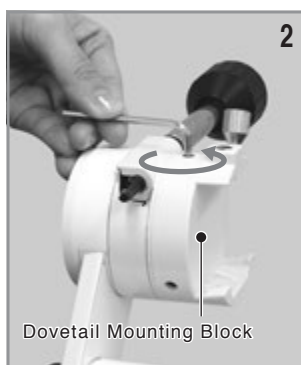

**3** The upper portion of the dovetail mounting block becomes loose. Turn the dovetail mounting block so that its position related to the altitude slow motion control handle is set to your desired position angle.



**4** Set the upper dovetail mounting block to the position which is snug fit and tighten the three hex socket screws securely.



**5** Replace the lock screw and attach the optical tube to the dovetail mounting block to finish.

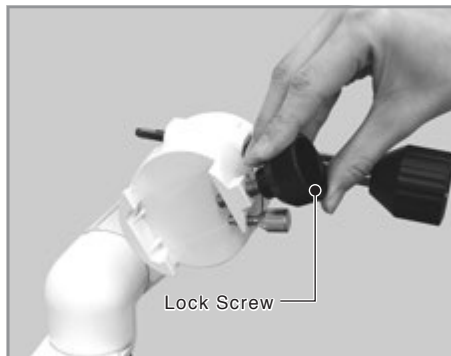



# PREPARATION

## 2. Change the position of the optical tube to the azimuth slow motion control handle.

**1** Remove the optical tube from the dovetail mounting block for safety. While holding the horizontal multi-arm in hand, loosen the safety screw first, and then, loosen the lock screw to remove the optical tube.

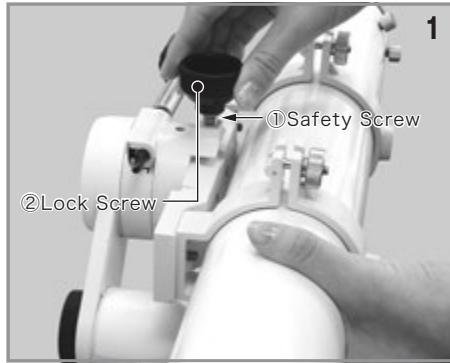

**2** Remove the white plastic cap on the slow motion control unit of the horizontal multi-arm. Take hold of the sides of the white plastic cap and pull out it upward as shown in the figure.

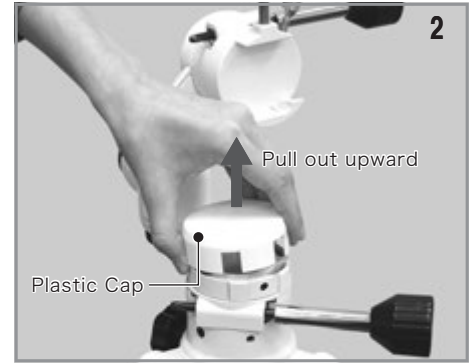

**3** There are three hex socket screws on the side of the upper block of the slow motion control unit. Loosen each of the screws with the 3mm Allen wrench while holding the horizontal multi-arm. (Do not loosen the screws too much.)



**4** The azimuth multi-arm becomes loose. Rotate the azimuth multi-arm so that its position related to the azimuth slow motion control handle is set to your desired position angle.

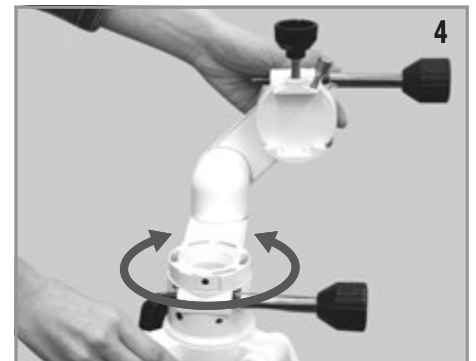

**5** Set the azimuth multi-arm to the position and tighten the three hex socket screws securely.



**6** Replace the white plastic cap on the slow motion control unit of the horizontal multi-arm.

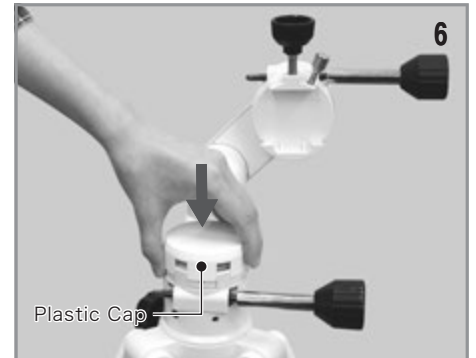

**7** Attach the optical tube to the dovetail mounting block to finish.



# PREPARATION

## IV. Preparation for Mounting the Optical Tube

**1** Turn the dovetail mounting block by hand so that the lock screw is on top.

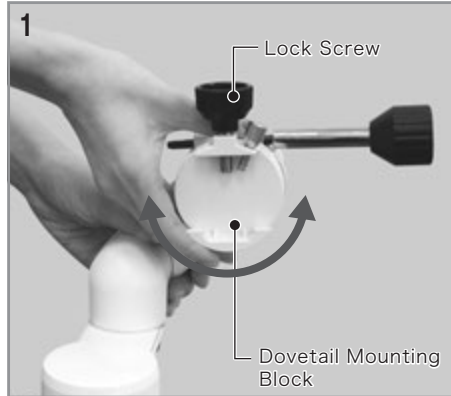

**2** Loosen both the lock screw and safety screw on the dovetail mounting block fully so that space is available to attach the dovetail attachment plate (or dovetail slide bar).

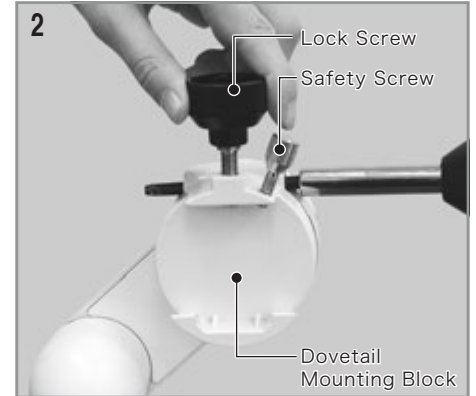

## V. Attaching the Optical Tube

Attach the optical tube to the dovetail mounting block so that the dovetail attachment plate fits the sunken adapter block neatly.

Tighten the lock screw first onto the centering notch of the dovetail attachment plate until snug. Then, tighten the safety screw securely. To remove the optical tube, loosen the safety screw first.

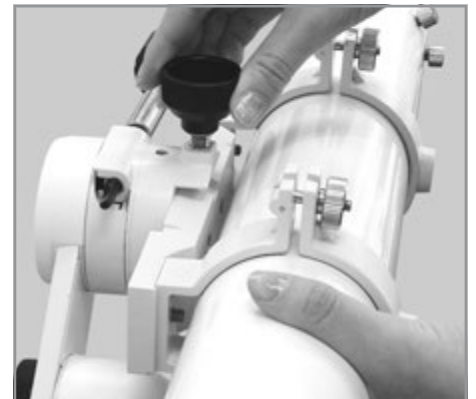
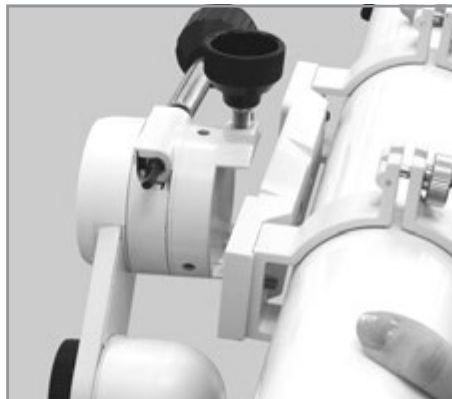

### ⚠ Caution

- Take care not to drop the optical tube as it could result in serious damage. Make sure that the lock screw is tightened firmly before you release your hand from the optical tube. Be sure to tighten the safety screw securely.

- Make sure that the dovetail attachment plate is flat against the sunken mounting block. Tightening the lock screw with a gap between these parts may cause the optical tube to fall.

Note: Rotate the optical tube as the need arises.

A70Lf: Loosen the lock knobs on the tube rings of the optical tube and rotate the optical tube.

A62SS: Rotate the focuser unit to change the orientation of the focus knobs/finder scope.

VMC95L: Move the position of the dovetail slide bar on the optical tube.



Make sure that the dovetail attachment plate is flat against the sunken mounting block.

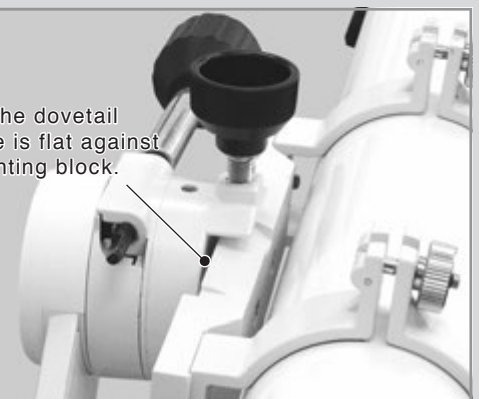

# PREPARATION

## IV. Inserting an Eyepiece to the Visual Back

Install necessary adapters for visual observation onto the visual back of your telescope and attach an eyepiece to it. The diagrams shown below are examples.

Note:

- The optical tube requires an eyepiece to view images.
- The eyepiece determines magnification of your telescope.
- The eyepiece may be accompanied with your optical tube if you purchased the product as a complete telescope package.

### Magnification of the Telescope

Dividing the focal length of the telescope by the focal length of the eyepiece gives the magnification.

When using an eyepiece with short focal length, a larger image is seen. However, the image becomes dimmer and the range of sharp focus becomes smaller.

Begin with an eyepiece with long focal length (large number in millimeters).

**Example: Using the eyepiece with an optical tube of 900mm long in focal length**

Eyepiece	Telescope focal length	÷	Eyepiece focal length	=	Magnification
PL 20mm	900mm	÷	20mm	=	45X
PL 6.3mm	900mm	÷	6.3mm	=	143X

### Visual Observing Configuration:

#### [A70Lf Visual Observing Configuration]

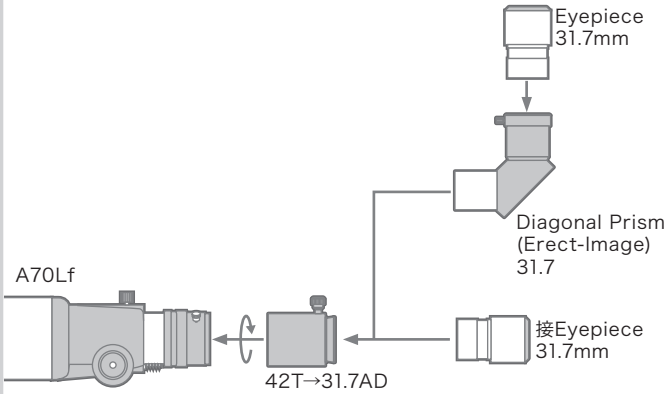

#### [A62SS Visual Observing Configuration]

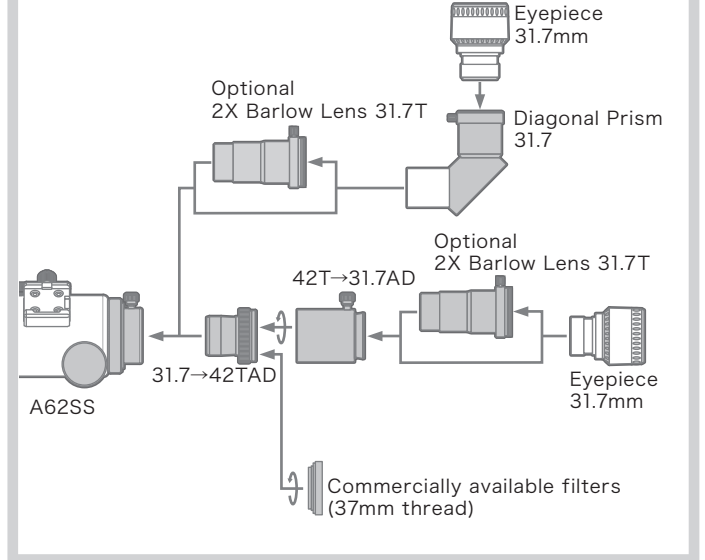

Note: If the 2X Barlow Lens 31.7T is used in combination with our item 3675 Diagonal Prism 31.7, it will produce an image enlarged by 3.3X.

#### [VMC95L Visual Observing Configuration]

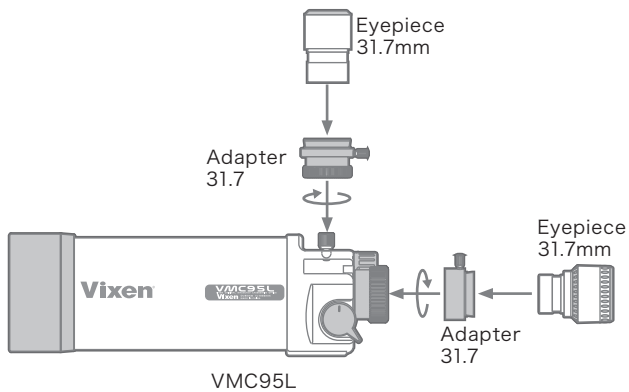

# PREPARATION

## VII. Attaching the Finder Scope

### Necessity of the Finder Scope

It is very difficult to find a target object while looking through a telescope which produces a relatively high magnification. A finder scope makes it easier to find the target object because of its low magnification and wider field of view. It is essential to align the finder scope before you use the telescope.

### VII-1 Attach the Finder Scope (MOBILE PORTA-A70Lf)

- 1 Remove the finder bracket lock thumb screws (2 pieces) on the telescope.
- 2 Attach the finder bracket on the telescope and put back the finder bracket lock thumb screws in place. Tighten the screws securely.

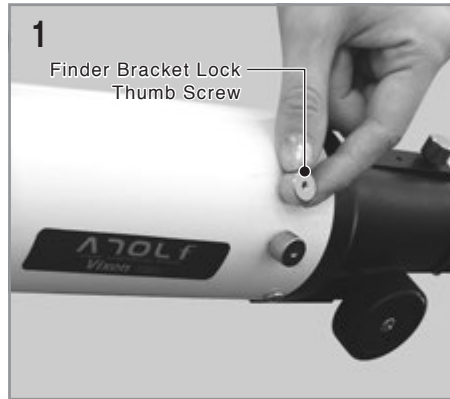

### VII-2 Attach the Finder Scope (MOBILE PORTA-A62SS, MOBILE PORTA-VMC95L)

- 1 Loosen the finder bracket lock thumb screw on the telescope.
- 2 Attach the finder bracket on the telescope and tighten the finder bracket lock thumb screws securely.

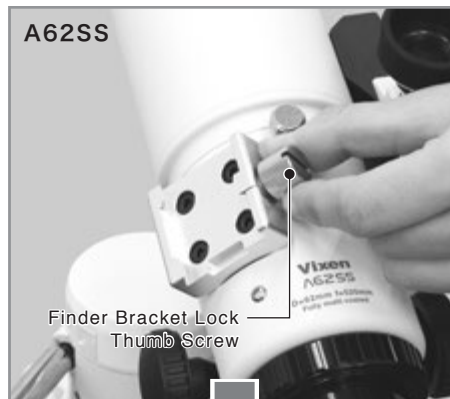

# PREPARATION

## VIII. Balancing the Optical Tube

If the optical tube attached on the Mobile Porta mount is not in balance, the optical tube may more. Shift it to the center of balance.

### VIII-1 Balance the optical tube for which the tube rings are used.

While holding the optical tube in the horizontal position, loosen slightly the lock screws on the tube rings so that the optical tube can slide.

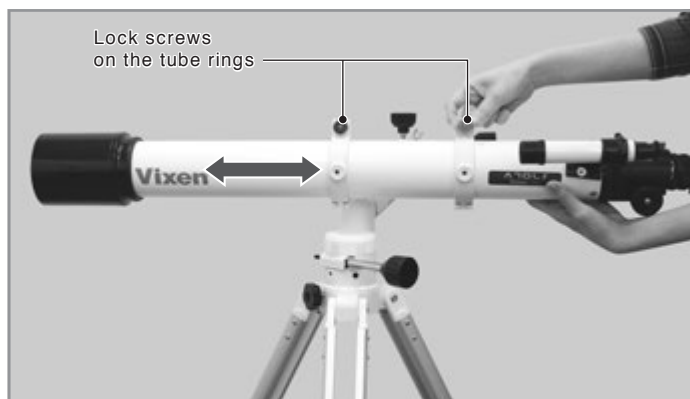

### VIII-2 Balance the optical tube for which the dovetail slide bar is used.

While holding the optical tube in hand, loosen the safety screw first, and then loosen the lock screw slightly. Slide the optical tube either forward or backward until it remains stationary.

Note: It may not be necessary to take this adjustment if the optical tube is lightweight and it stands still.



# PREPARATION

## © Operating the MOBILE PORTA Mount

### I. Quick Slewing Motion

The MOBILE PORTA mount employs a friction stop mechanism which allows you to move the optical tube by hand so that you can quickly point it at your target object. The optical tube moves as you guide it by hand and stops as you release.

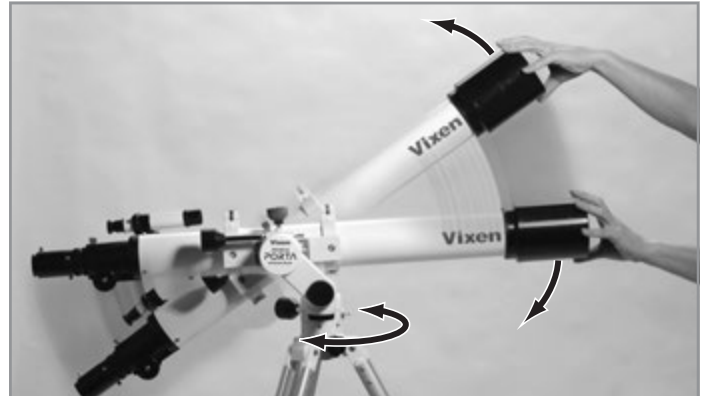

Note: The tension of the friction stop motion can be adjusted in the altitude and azimuth directions as the need arises.

### II. Fine Motion and Tracking

With high magnification, it will be very hard to keep centering the target object in the field of view of the telescope by grasping the optical tube and moving it. Use the slow motion control handles for fine target positioning and to keep tracking the target in the field of view.

Rotating the vertical slow motion control handle allows you to shift the optical tube by inches in the altitude direction. And rotating the horizontal slow motion control handle allows you to shift the optical tube by inches in the azimuth direction.

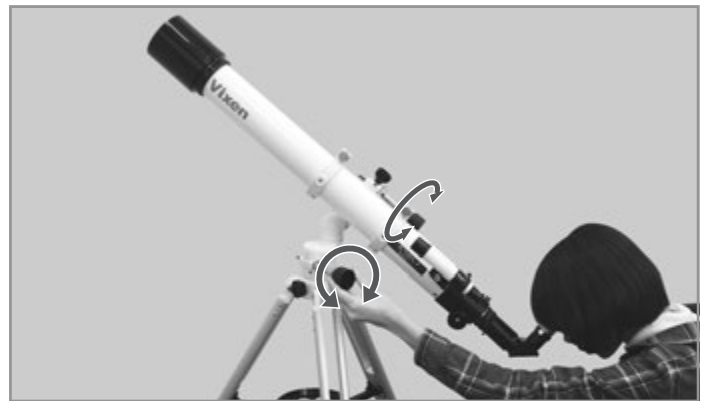

### III. Viewing Terrestrial Landscape

It is difficult for a novice amateur astronomer to operate the telescope in the dark at night. First of all, we recommend that you practice the operation of the telescope in daytime. Let's start with viewing terrestrial landscapes with the telescope.

Set up the telescope in a place where you can see an object at least 200m away. (The telescope does not reach focus at close range.) Be sure to use the telescope outdoors.

Take off the objective lens cap in the front of the optical tube and insert a low magnification eyepiece (large number in mm) into the visual back to begin the terrestrial observing.

Note: The image will be blurred or double if you look through the telescope through window glass in the room. If the window is opened and still there is difference in temperature between the room and outdoors, air current flown out from the room can cause turbulence and the image will not be stabilized.



# PREPARATION

## IV. Aligning the Finder Scope

It is very difficult for the telescope user to locate a target celestial object through the telescope itself as its field of view is narrow, even if its magnification is low. The use of a finder scope will make it much easier. The finder scope is a secondary small telescope with low magnification and wide field of view. Typically there are cross hairs in the finder scope's field of view so that you can aim it at the target celestial object properly.

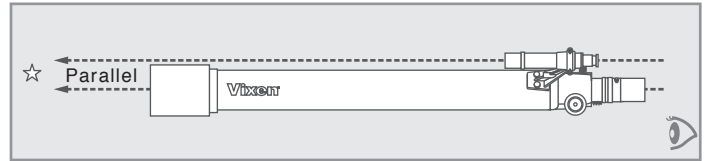

**Be sure to align the finder scope with the telescope's field of view before you start observing. It is highly recommended to do this in daytime.**

### IV-1 Aligning the 6X24 Finder Scope on the A70Lf

**1** Choose a conspicuous target in the distance (over 200m away) and place the target in the center of a field of view of the telescope. The image in the telescope's field of view is usually upside down.

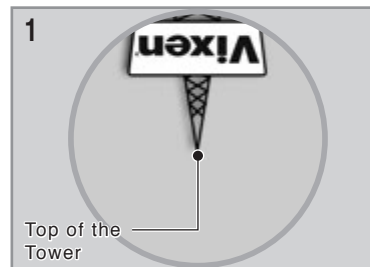

The target is close to the center in the telescope's field of view.



**2** Next, look through the finder scope. You should probably find the same target somewhere within the finder scope's field of view. In the illustration on the right, the tower is seen in the upper right of the finder scope's field of view. The finder scope has cross hairs.

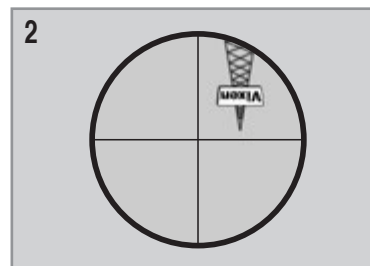

Finder scope's field of view.



**3** While looking through the finder scope, align the field of view with the telescope's field of view by loosening or tightening the adjustment screws on the finder bracket so that the target comes close to the center of field of view.

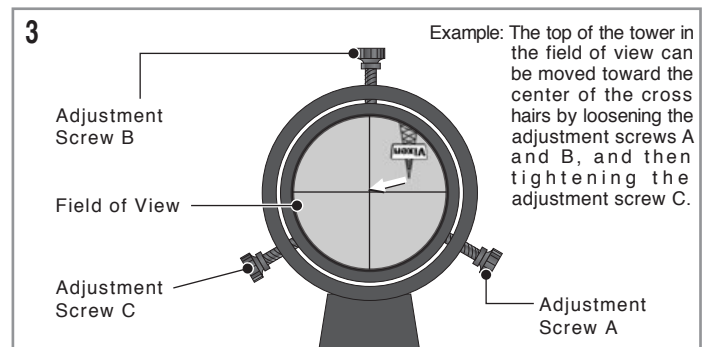

# PREPARATION

## IV-2 Aligning the XY Red Dot Finder II on the VMC95L/A62SS

- 1** Choose a conspicuous target in the distance (over 200m away) and place the target in the center of a field of view of the telescope. The image in the telescope's field of view is usually upside down.

Note: Turn the flip mirror of the visual back to straight viewing before starting a finder adjustment.

The target is close to the center in the telescope's field of view.



- 2** Turn on the XY red dot finder II by turning the brightness adjustment dial to illuminate a red dot at the maximum.

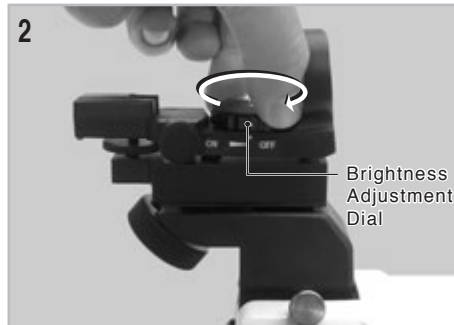

- 3** You will see the red dot on the center of the front aiming window, when you look along the rear white sight line of the XY red dot finder II.

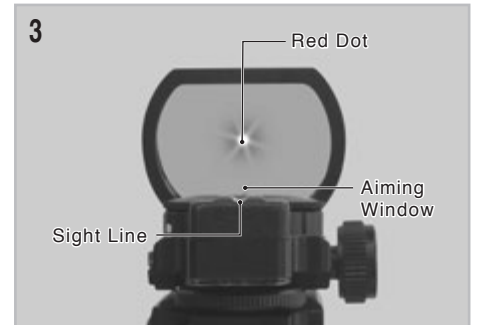

- 4** You should probably find the same target somewhere in the field of view of the front aiming window.



- 5** While holding the finder body, loosen the alignment clamp and roughly adjust the orientation of the finder body so that the red dot and the target overlap each other.

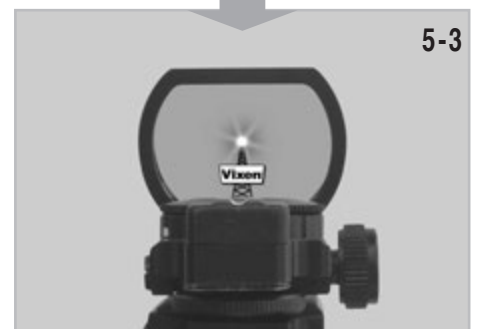
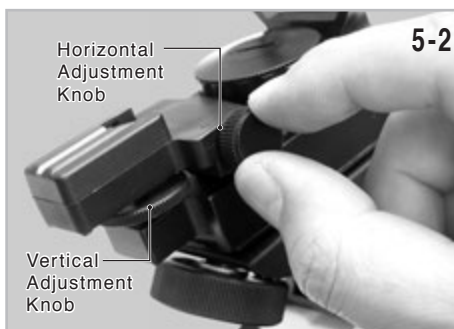
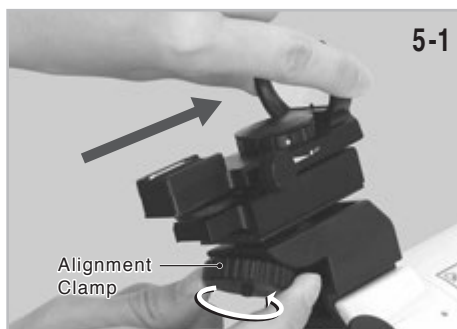

- 6** Tweak the vertical and horizontal fine adjustment knobs on the XY red dot finder II to place the target accurately to the red dot in the center of the front aiming window.



# OBSERVATION

## Observing the Moon

With the finder scope aligned and the eyepiece attached, you are ready to use the MOBILE PORTA telescope for your celestial observation in the night sky. Let's begin by observing a bright and easy-to-find object, the Moon, and then, proceed to finding planets and dark objects easily visible at moderate magnification.

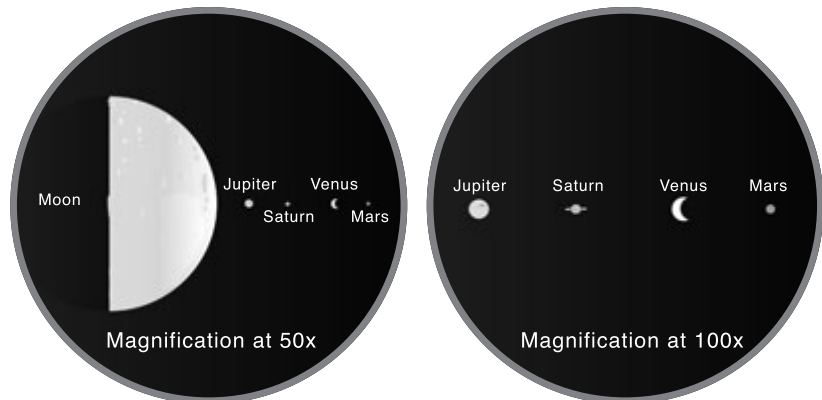
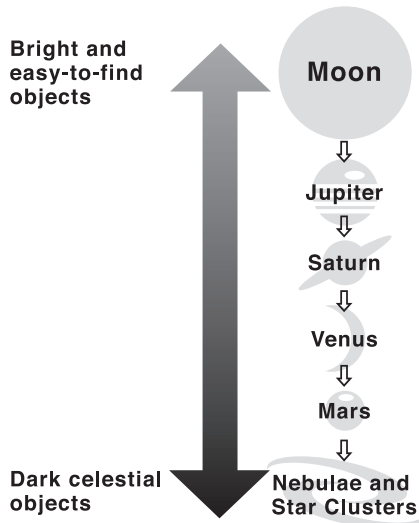

Above : What you can expect to see when viewing at a different magnification.

**1** Point your MOBILE PORTA telescope at the Moon by slewing the telescope tube by hand. Locate the Moon in the finder scope (or the red dot finder). Center the Moon in the finder scope using the slow motion control handles.

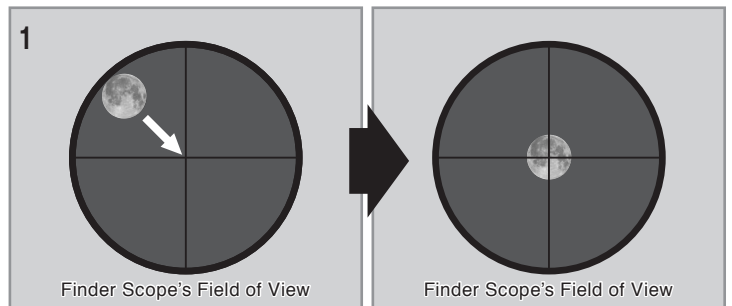

**2** Look through the telescope with an eyepiece of low magnification and the Moon will be there. Focus the telescope on the Moon by turning the focus knob.

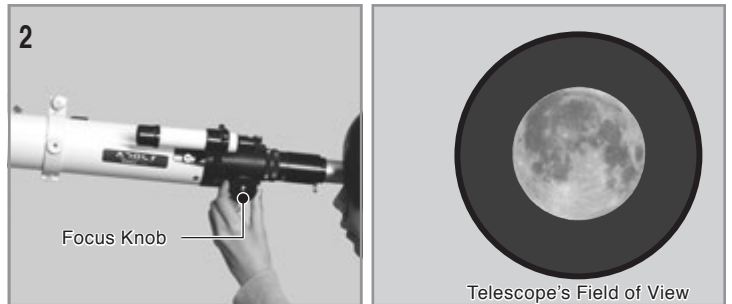

**3** Try using a different eyepiece to change the magnification.

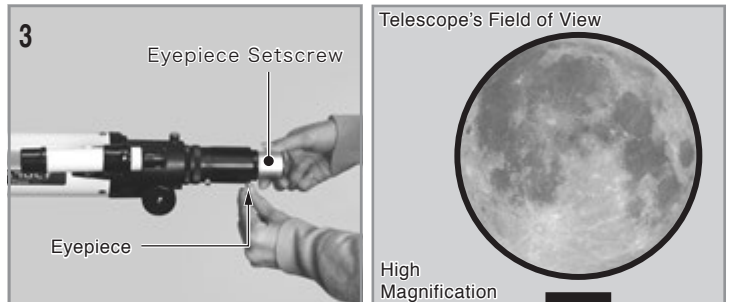

**4** The Moon (stars and other celestial objects as well) appears to move out of the field of view while looking through the telescope due to the Earth's rotation. The higher the magnification, the faster the movement. Turn the slow motion control handles to bring the Moon into the center of the field of view again.

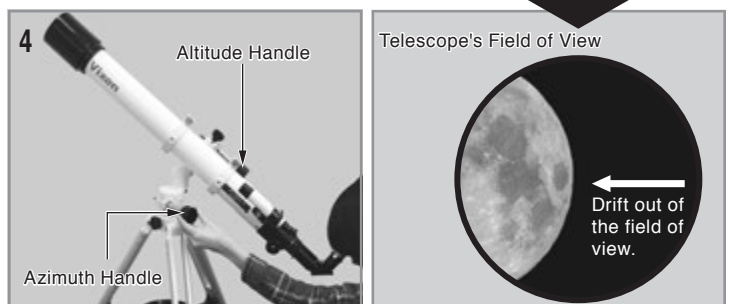

# APPLICATION

## Accessories Chart for Astro-Photography

### Photographic Configuration of the A70Lf and A62SS

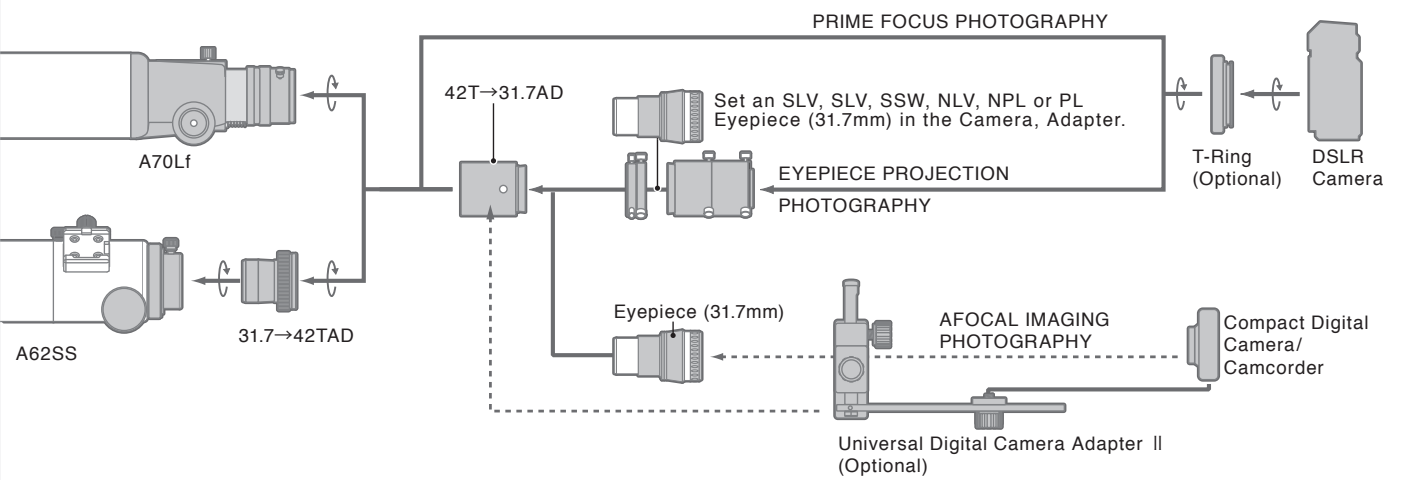

### Photographic Configuration of the VMC95L

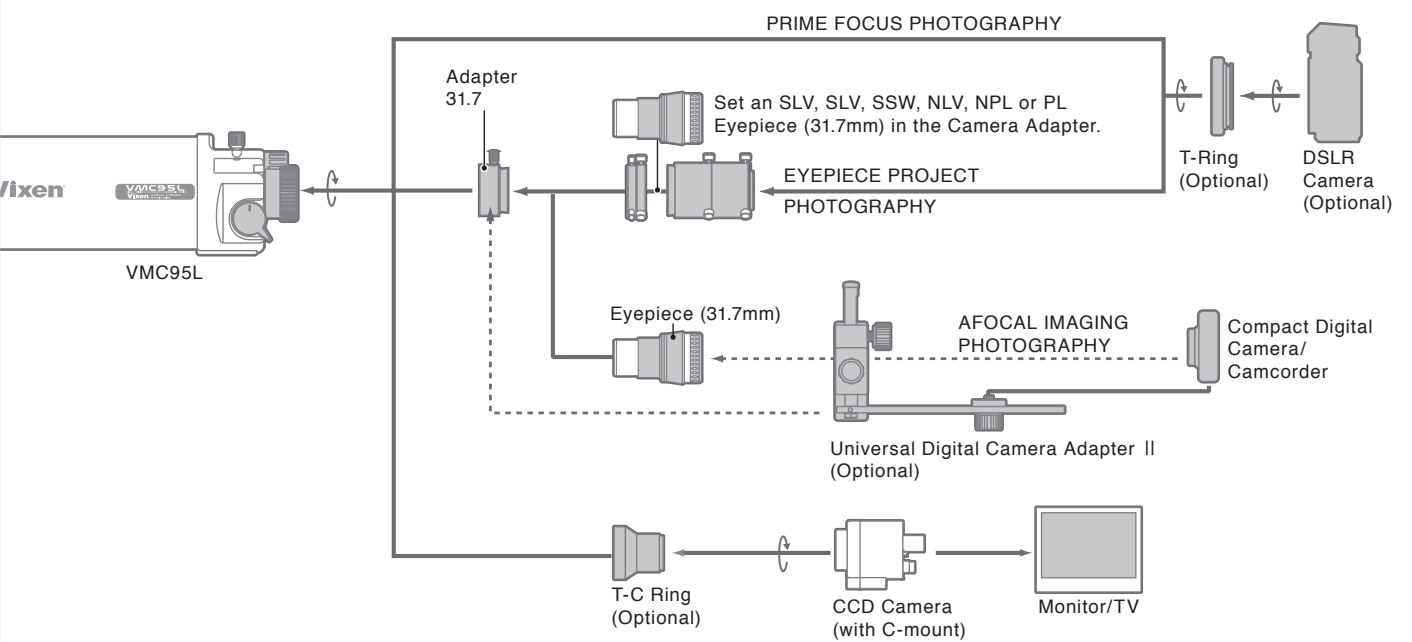

# SPECIFICATIONS

## MOBILE PORTA Mount

Mount	MOBILE PORTA Altazimuth Mount
Vertical and Horizontal Slow Motions	Worm and wheel gears with 90-tooth whole-circle movement, Friction stop mechanism, complete with slow motion control handles
Optical Tube Attachment	Dovetail tube-plate attachment system, with safety screw
Maximum Loading Weight	3.5 kg / 7.7 lb.
Tripod	Two-section aluminum legs, with accessory tray
Tripod Adjustable Length	Adjustable from 640mm to 1140mm in height (from 720mm to 1290mm in length), Setup space between 410mm and 700 mm in radius.
Total Weight (Mount only)	2.4 kg (1.0 kg) / 5.28 lb. (2.2 lb.)

## MOBILE PORTA Mount Packages

Model	MOBILE PORTA-A80Mf	MOBILE PORTA-A62SS	MOBILE PORTA-VMC95L
Objective Lens or Mirror	70mm achromatic lens	62mm achromatic lens	95mm precision spherical mirror
Lens or Mirror Coatings	Multi-coatings	Multi-coatings	Multi-coatings
Focal Length (F Ratio)	900mm (F/12.9)	520mm (F/8.4)	1,050mm (F/11.1)
Resolving Power, Limiting Magnitude	1.66 arc. Seconds, 11.0	1.87 arc seconds, 10.7	1.22 arc seconds, 11.7t
Light Gathering Power	100X unaided eye	78X unaided eye	184X unaided eye
Optical Tube Dimensions	860mm L X 76mm dia.	370mm L (305mm for storage) X 75mm dia.	360mm L X 107mm dia.
Optical Tube Weight	2.5 kg (Net 1.9 kg) / 5.5 lb. (Net 4.18 lb.)	1.8 kg (Net 1.5 kg) / 3.96 lb. (Net 3.3 lb.)	2.0 kg (Net 1.8 kg) / 4.4 lb. (Net 3.96 lb.)
Finder Scope	6x24mm, 5-degree FoV	XY Red Dot Finder II	
Visual Back	42mm thread for T-ring, 31.7mm push fit	42mm thread for T-ring, 37mm thread for filter, 31.7mm push fit	42mm thread for T-ring, 31.7mm push fit
Eyepiece	PL20mm (45X, 65' FoV) PL6.3mm (143X, 22' FoV)	NPL10mm (52X, 58' FoV)	NPL20mm (53X, 57' FoV)
Standard Accessories	Erect-image Diagonal Prism	Diagonal Prism, 2X Barlow Lens, Carry Case for optical tube	Built-in Flip Mirror, 2X Barlow lens
Astrophotography	Applicable to Prime Focus, Eyepiece Projection and Afocal Imaging		
Total Weight (w/o Eyepiece)	4.9 kg / 10.8 lb.	4.2 kg / 9.25 lb.	4.4 kg / 9.7 lb.

**Vixen®**