



iOptron[®] CEM120 Center-Balanced Equatorial Mount

Instruction Manual

Product #7300 and#7301



Read the Instruction BEFORE setting up and using the mount! Worm/gear system damage due to improperly use will not be covered by warranty.

If you have any questions please contact us at support@ioptron.com



WARNING!

***NEVER USE A TELESCOPE TO LOOK AT THE SUN WITHOUT A PROPER FILTER!
Looking at or near the Sun will cause instant and irreversible damage to your eye.
Children should always have adult supervision while using a telescope.***

Table of Contents

Table of Contents	3
1. CEM120 Introduction	6
2. CEM120 Terms	7
2.1. Parts List	7
2.2. Identification of Parts	8
2.3. CEM120 Mount Basic Cable Connection	9
2.4. CEM120 Cable Management	9
2.5. Go2Nova [®] 8407+ Hand Controller	12
2.5.1. Key Description	12
2.5.2. The LCD Screen	13
2.6. Check the Battery	14
3. CEM120 Mount Assembly	15
4. Getting Started	22
4.1. Setting the Mount and Performing Polar Alignment	22
4.2. Manual Operation of the Mount	22
4.3. Initial Star Alignment	22
4.4. GOTO the Moon and Other Objects	22
4.5. Star Identification Function	23
4.6. Power-Down Memorization	23
4.7. Turning Off the Mount	23
5. Complete Functions of Go2Nova [®] 8407+ Hand Controller	24
5.1. Select and Slew	24
5.1.1. Solar System	24
5.1.2. Deep Sky Objects	24
5.1.3. Stars	24
5.1.4. Comets	24
5.1.5. Asteroids	24
5.1.6. Constellations	24
5.1.7. Custom Objects	24
5.1.8. Customer R.A. and DEC	25
5.2. Sync to Target	25
5.3. Alignment	25
5.3.1. Position of Polaris/SigmaOct	25
5.3.2. One Star Alignment	25
5.3.3. Two Star Alignment	25
5.3.4. Three Star Alignment	26
5.3.5. Solar System Align	26
5.3.6. Polar Iterate Align	26
5.3.7. View Model Error	26
5.3.8. Clear Alignment Data	26
5.4. Settings	26
5.4.1. Set Time and Site	26
5.4.2. Beep Settings	27
5.4.3. Display Settings	27
5.4.4. Set Guiding Rate	27
5.4.5. Set Tracking Rate	28
5.4.6. Set Parking Position	28

5.4.7. Meridian Treatment	28
5.4.8. Set Altitude Limit	28
5.4.9. Enable CW Up Position	28
5.4.10. HC Heating Switch	29
5.4.11. Set RA Guiding	29
5.4.12. Network Options	29
5.4.13. Power LED Switch	29
5.4.14. Reset All Settings.....	29
5.4.15. Language.....	29
5.5. Electric Focuser	30
5.6. PEC Option	30
5.6.1. PEC Playback.....	30
5.6.2. Record PEC.....	30
5.6.3. PEC Data Integrity	30
5.7. Park Telescope.....	30
5.8. Edit User Objects	31
5.8.1. Enter a New Comet.....	31
5.8.2. Enter Other Objects or Observation List	31
5.9. Firmware Information.....	32
5.10. Zero Position.....	32
5.10.1. Goto Zero Position.....	32
5.10.2. Set Zero Position.....	32
5.10.3. Search Zero Pos.	32
6. Maintenance and Servicing.....	33
6.1. Maintenance.....	33
6.2. iOptron Customer Service.....	33
6.3. Product End of Life Disposal Instructions.....	33
6.4. Battery Replacement and Disposal Instructions	33
Appendix A. Technical Specifications	34
Appendix B. Go2Nova® 8407+ HC MENU STRUCTURE.....	35
Appendix C. Firmware Upgrade.....	38
Appendix D. Computer Control a CEM120 Mount.....	39
Appendix E. Go2Nova® Star List	40
IOPTRON TWO YEAR TELESCOPE, MOUNT, AND CONTROLLER WARRANTY	46

Instruction for CEM120 Gear Switch and Axle Locking Knob

Both RA and DEC have the same Gear Switch and Axle Locking Knob, the operations are the same.





Gear Switch



Axle Locking Knob

As an example, here are the positions for the Gear Switch and Axle Locking Knob for RA axis:

A: When transferring or installing the mount, lock the Axle Locking Knob and disengage the Gear Switch  (they are parallel to each other). So the RA won't swing and there is no force applied onto the worm/ring gear.

B: During mount balancing process, release the Axle Locking Knob and leave the Gear Switch at disengaged position  (they are perpendicular to each other). Now the mount will swing freely in RA direction.

C: During normal operation of the mount, *i.e.*, GOTO and tracking, turn the Gear Switch to locking position  to engage the worm/ring gear while leave the Axle Locking Knob released (they are parallel to each other again).



A. During transferring and installing...



B. During balancing...



C. During operating...

ONLY set the Gear Switch at locking position to engage the worm/ring gear during goto, slew or tracking.

ALWAYS lock the Axle Locking Knob during transferring and installing.

1. CEM120 Introduction

Welcome to a new type of equatorial mount – the iOptron® Center-Balanced Equatorial Mount, or CEM! It offers the benefits of our revolutionary “center balance” design: stability, accuracy, and smooth mechanical operation, while capable of carrying a payload up to 115 lbs (52 kg). The “center balance” design’s natural stability is due to its focusing the mount along with payloads weight directly over the center of the pier or tripod.

The CEM120's performance is demonstrated by its low periodic tracking error of ± 3.5 arc seconds (< 0.15 arcsec RMS for CEM120EC). Along with the stability aspect, the CEM120 features an advanced cable management system consisting of more ports in more locations preventing tangle ups and reducing the chance of fractured cables. It also adds some new features to the CEM family like Wi-Fi and LAN for remote operation and easy to use, reliable clutches on both axes.

The CEM12 mount is equipped with the most advanced GOTO NOVA® GOTO technology, making it one of the most powerful and accurate GOTO mounts available. The Go2Nova® 8407+ hand controller has a database of over 212,000 objects making it easy to locate even the faintest celestial objects.

Features:

- A new design, center-balanced equatorial mount (CEM) for maximum payload with natural stability
- Observatory astrophotography mount ideal for both visual and Astro-photographers
- Payload of 115 lbs (52 kg) with the mount weight of 57 lbs (26 kg)
- Easy to use and reliable gear clutches
- Precision altitude and azimuth adjustment.
- Precision stepper motor with 0.07 arcsec accuracy for precise GOTO and accurate tracking
- Polar alignment routine for those who can't see the Pole Star
- Go2Nova® 8407 V2 controller with Advanced GOTO NOVA® GOTO Technology with built in heater
- High precision tracking with low periodic error: PE $< \pm 3.5$ arcsec for #7300, or PE < 0.15 arcsec RMS for #7310
- Permanent periodic error correction (PPEC) (#7300) or Real-time periodic error correction (RPEC) (#7301)
- Built-in 32-channel Global Positioning System (GPS)
- Built-in WiFi and LAN for remote operation
- Integrated ST-4 autoguiding port
- AutoZero™ technology for mount remote operation
- Power-down memorization of GOTO and tracking position
- Advanced cable management system with more choices
- Spring loaded, individual adjustable Losmandy saddle

2. CEM120 Terms

2.1. Parts List¹

SHIPPING CONTENTS

Your new CEM120 mount comes in two shipping boxes. One box contains either a CEM120 (#7300) or CEM120EC (#7301) mount head, hand controller, and accessories. The other box contains a 22lb (10kg) counterweight and counterweight shaft. The contents are:

- 1X iOptron® CEM120 telescope mount (#7300, with silver adjustment knobs) or iOptron® CEM120EC mount (#7301, high precision model with red adjustment knobs)
- 1X Go2Nova® 8407 V2 Hand Controller
- 1X 22lb (10 kg) counterweight
- 1X Stainless steel counterweight shaft
- 1X 12V/5A AC/DC adapter (100V-240V)
- 1X Hand Controller Cable (6P6C RJ11 to RJ11, straight wired)
- 1X Serial cable (RS232 to RJ9)
- 4X Base mounting screws
- 1X GPS external antenna
- 1X Wi-Fi external antenna

OPTIONAL PARTS

- Electronic polar scope adapter (#3337-120)
- Pier top mounting plate
- USB to RS232 Converter with FTDI chipset (#8435)

ONLINE RESOURCES *(click on the “Support” menu at www.iOptron.com)*

- Quick Start Guide
- Instructional manual
- Tips for set up
- Hand controller and mount firmware upgrades (check online for latest version)
- iOptron ASCOM driver
- Reviews and feedback from other customers
- Accessories

¹ US market only. Actual contents may vary.

2.2. Identification of Parts

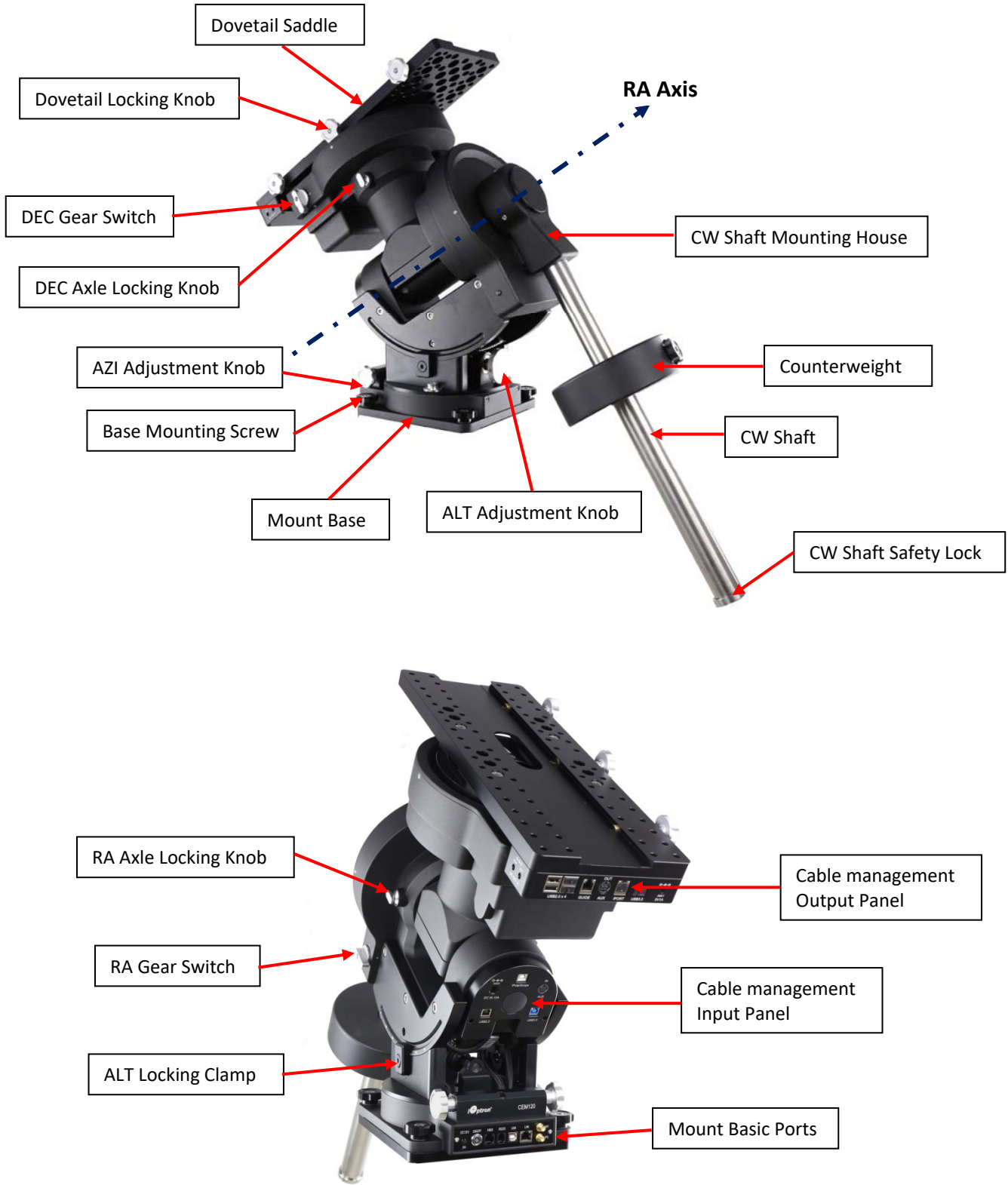

Figure 1.CEM120 mount assembly

2.3. CEM120 Mount Basic Cable Connection

The basic cable connection ports of a CEM120 mount are all located on the mount base, as shown in Figure 2.



Figure 2. Ports on a CEM120 mount base

- DC 12V 5A: DC power socket to power the mount (2.5mmX5.5mm, 5525)
- ON/OFF: Power Switch
- HBX (Hand Box): For connecting to an 8407 Hand Controller
- RS232: Serial port for mount computer control and firmware upgrade
- USB: USB port for mount computer control
- LAN: network connection for remote control
- WiFi: Mini coaxial cable connector for WiFi antenna
- GPS: Mini coaxial cable connector for GPS external antenna

2.4. CEM120 Cable Management

The CEM120 mount has a pre-wired Cable Management System that allows the user to connect their accessories and imaging equipment without cables tangling or snagging when the mount is slewing or tracking. The Cable Management Outputs are located at the back of the dovetail saddle, as shown below.



Figure 3. Connects at the end of the dovetail saddle

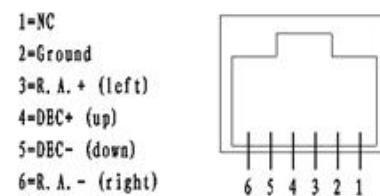

Figure 4. GUIDE port wiring

At the end of the dovetail saddle, there are

- USB 2.0 x 4: 4 USB 2.0 ports with standard type A connectors for connecting accessories (un powered). They were connected to the USB2.0 input on Input Panel.
- GUIDE: port for autoguiding with ST-4 cable. The wiring is shown in Figure 4.
- AUX (OUT): A DIN-422 port for high power or other connection purpose. It is connected to the AUX (IN) port on Input Panel.

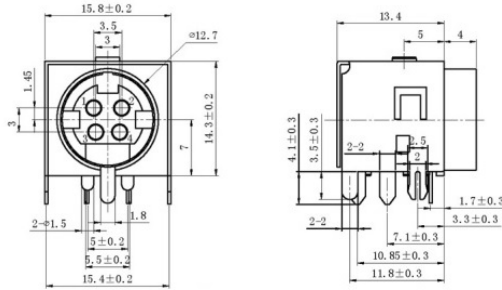

Figure 5. AUX port DIN-422 socket

- iPORT: for iOptron compatible accessories, such as electrical focuser.
- USB 3.0: Powered USB 3.0 port. It is connected to the USB3.0 input on the Input Panel.
- 5521 **5V1A** socket: a 2.1mmX5.5mm 5V DC power output for accessories. Maximum 1A, center positive. This is provided by mount DC 12V power.

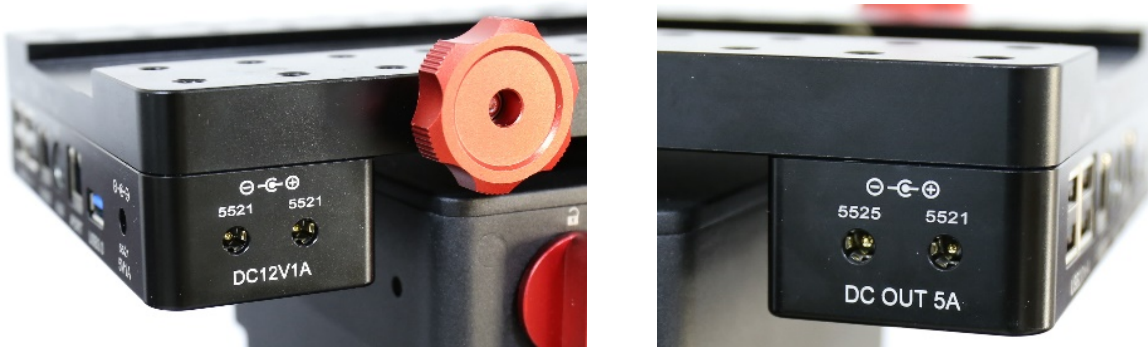

Figure 6. Power output sockets

On the side of the dovetail saddle, there are 4 power output sockets:

- 5521 12V1A socket X2: There are two 12V1A DC output sockets on the right end side of the dovetail saddle, with 2.1mmX5.5mm, center positive sockets. They are provided by mount DC 12V power.
- On the left end side of the dovetail saddle, there are one 5525 (2.5mmx5.5mm) and one 5521 (2.1mmX5.5mm) DC output sockets for your accessories. The maximum specified current output is 5A. They are connected to the DC IN 10 port on the Input Panel. The voltage is determined by the input voltage, such as V, 12V or 24V.



Figure 7. Cable Management System Input Panel

The ports on the Cable Management Panel are connected to the Input Panel located at the end of the mount RA axis, as shown in Figure 7:

- 1X DC IN 10A power input (2.5mmX5.5mm, 10A max.)
- 1X USB 2.0 port with a standard type B connector
- 1X USB 3.0 port
- 1X AUX IN port (for data or extra power input)
- iPolarScope port for electronic polar scope connection

2.5. Go2Nova[®] 8407+ Hand Controller



Figure 8. Go2Nova[®] 8407+ hand controller

The Go2Nova[®] 8407+ hand controller (HC) shown in Figure 8 is the standard controller used on the CEM120 mount. It has an integrated heater that ensures the LCD display will work at the temperature as low as -20°C(-4°F). It has a large LCD screen, function, direction, and number keys on the front; a red LED reading light on the back; and a HBX (6-pin) and a serial port (4-pin) at the bottom.

2.5.1. Key Description

- MENU Key: Press “MENU” to enter the Main Menu.
- BACK Key: Move back to the previous screen, or end/cancel current operation, such as slewing.
- ENTER Key: Confirm an input, go to the next menu, select a choice, or slew the telescope to a selected object.
- Arrow (▲▼◀▶) Keys: The arrow keys are used to control the movement of DEC and R.A. axes. Press and hold ▲(DEC+), ▼(DEC-) buttons to move a telescope along the DEC direction, ◀(R.A.+), ▶(R.A.-) to move a telescope along the R.A. direction. They are also used to browse the menu or move the cursor while in the menu. Press and holding an arrow key for a fast scrolling.
- Number Keys: Input numerical values. Also used to adjust speeds (1: 1X; 2: 2X; 3: 8X; 4: 16X; 5: 64X; 6: 128X; 7: 256X; 8: 512X; 9: MAX)
- Light Key(☀): Turns on/off the red LED reading light on the back of the controller.
- Help (?) Key: Identify and display bright stars or objects that the telescope is pointing to.
- STOP/0 Key: Stop the mount during GOTO. Also toggling between starting and stopping tracking.
- HBX (Handbox) port: connect the HC to a mount using a 6P6C RJ11 cable.

- Serial port: connect the HC to a computer via a RS232 to 4P4C RJ9 cable. The pin-out of the serial port is shown in Figure 9.

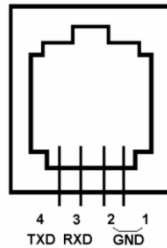

Figure 9. Serial port pin-out on an 8407+ hand controller

2.5.2. The LCD Screen

The 8407+ HC has a large 8-line, 21-character per line, LCD screen which displays information on the status of the mount as shown in Figure 10. The user interface is simple and easy to operate.

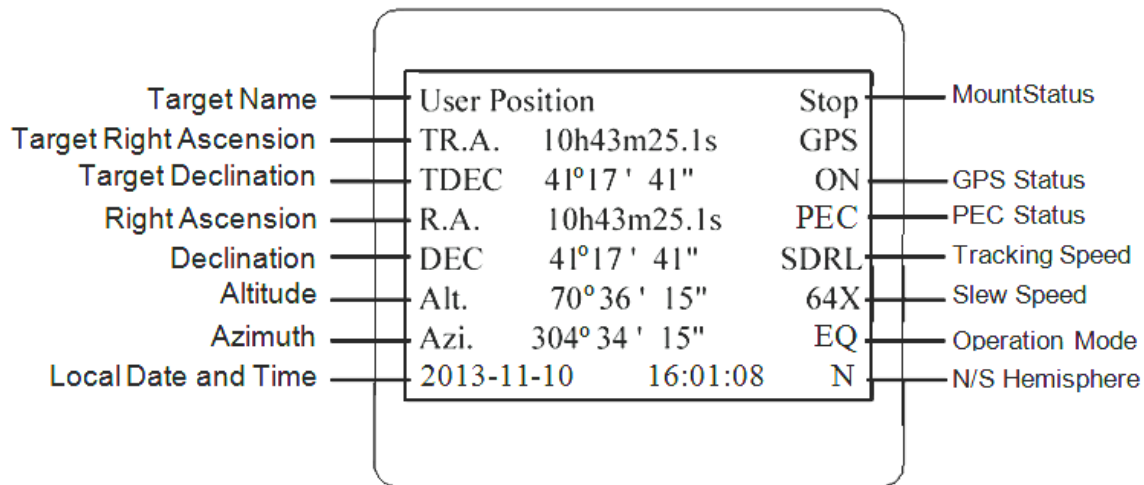

Figure 10. 8407+ HC LCD Information Screen

- Target Name/Mount Position: displays the name of the target that telescope is currently pointed to or the current mount position.
 - Zero Position: The reference position for GOTO. The mount can move to Zero Position using **"Goto Zero Position"** or **"Search Zero Position"** command;
 - User Position: The mount is pointed to a user defined position, which could be a particular celestial object or simply a position determined by pressing an arrow key;
 - An object name, such as "Mercury" or "Andromeda Galaxy": Name of the star or celestial object that the mount is currently slewing to or tracking.
- Target R.A.: Right Ascension (R.A.) of the target object.
- Target Declination: Declination (DEC) of the target object.
- Right Ascension: Current R.A. of the telescope.
- Declination: Current DEC of the telescope.
- Altitude: Altitude of the telescope (degrees vertical from the local horizon - zenith is 90°).
- Azimuth: Azimuth of the telescope (north is 0°, east is 90°, south is 180°, and west is 270°).
- Local Date and Time: displays the local time in a format of YY-MM-DD HH:MM:SS.
- Mount Status: Displays the current operational status of the mount.
 - Stop: mount is not moving;

- Slew: mount is moving with an arrow key is pressed or a GOTO command, such as “**Select and Slew**” or “**Goto Zero Position**”;
 - Tracking: mount is at a tracking status.
10. GPS status: When the power is turned on, the initial GPS status will be “GPS ON”, which means that the mount is connected to its GPS receiver and is seeking a satellite signal. When the GPS receiver finds the satellites and receives the GPS signal the status will change to “GPS OK”.
 11. PEC status: Display of “PEC” here Indicates the Periodic Error Correction playback is turned on. Default is off.
 12. Tracking speed: Displays the current tracking rate of the mount.
 - SDRL: mount is tracking at sidereal speed;
 - Solar: mount is tracking at solar speed;
 - Lunar: mount is tracking at lunar speed;
 - King: mount is tracking at king speed;
 - CSTM: mount is tracking at a custom, user-defined speed.
 13. Slew speed: The mount has 9 slew speeds: 1X, 2X, 8X, 16X, 64X, 128X, 256X, 512X, MAX(4°/sec).
 14. Operation Mode: EQ indicates that the mount is operating in an equatorial mode.

2.6. Check the Battery



The hand controller has a real time clock (RTC) which should display the correct time every time the mount is turned on. If the time is incorrect, please check the battery inside the hand controller and replace it if needed. The battery is a 3V, CR1220 button battery.

3. CEM120 Mount Assembly

STEP 1. Attach the Mount

Make sure that the RA axle is at the locking position (*please refer to the charts on page 5*). Remove the mount from the package. Put it onto a pier/tripod top and secure it with four included Base Mounting Screws.

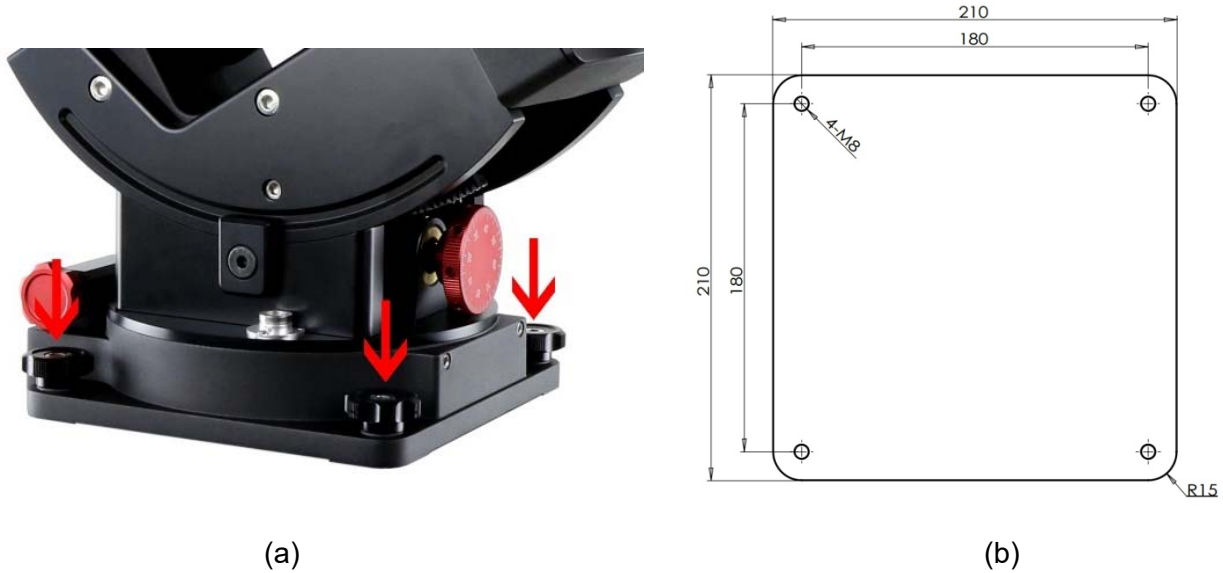

Figure 11. (a) Attach the mount, and (b) mount base dimension

Because of the total weight of the mount, counterweight and payload, we recommend use your own pier for the mount. The base dimension is shown in

STEP 2. Install the Counterweight (CW) Shaft

Hold the mount head with one hand. Pull the RA Axle Locking Knob outward to disengage the lock. Slowly rotate the mount RA 90 degree to level position. Release the RA Axle Locking Knob to lock the RA axis again.



Figure 12. Install CW shaft

Remove the CW shaft from the package and threaded it onto the CW shaft mounting house. **DO NOT** release the RA Axle Lock before the CW shaft is fully threaded in. The CW shaft is designed to balance the mount head weight.

DO NOT rock the counterweight shaft rigorously. It may damage the worm system.

STEP 3. Adjust Altitude

This step requires you to know the latitude of your current location. This can be found from your 8407+ hand controller after the embedded GPS receives the signal from the satellites. It can also be easily found on the Internet, using a GPS satellite-navigation system, or a GPS capable cell phone. You will have to change this latitude setting every time you significantly change your night sky viewing location. Note that this setting directly affects the mount's GOTO accuracy.

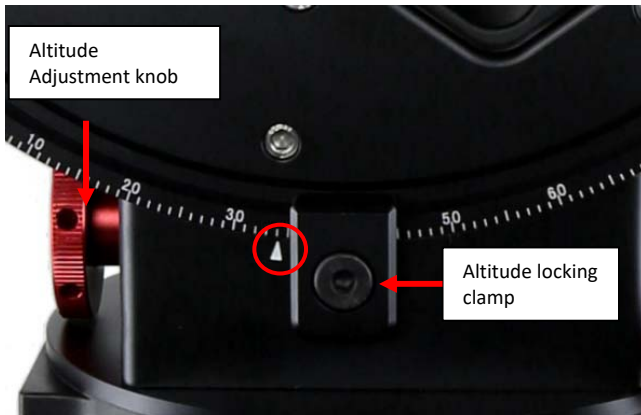

Figure 13. Setting the latitude



Figure 14. Latitude Adjustment Knob

Slightly loosen the Altitude Locking Clamps about a quarter (1/4) turn with a 5mm Allen wrench, on both side of the mount. Turn the Altitude Adjustment Knob until the arrow points to your current latitude on the Latitude Scale, as shown in Figure 13. Tighten the Altitude Locking Clamps when done.

The altitude adjustment employs worm gear system and can be adjusted precisely when turn in one direction. The fine adjustment is 0.5 arcmin.

The mount latitude adjustment range is from 0° to 68°. **For those low latitude places between 0° to 10°, a special CW shaft mounting block is needed.**

STEP 4. Install the Counterweight(s) and Telescope

Before installing the Counterweight(s), make sure that mount is at Zero Position, i.e., CW shaft is pointing to ground. Both R.A. and DEC Axle Locking Knobs are at the locking position (refer to **Illustration A on page 5**).

Remove the CW Safety Cap at the end of CW Shaft. Guide the CW over the shaft. Tighten the CW Locking Screw to hold the CW in place. Place the Safety Cap back onto the shaft.



WARNING: The mount should always be kept in the zero position while it is being loaded with CWs and payload.



Figure 15. Loading counterweight

You may need more CW for heavier payload, or smaller size CW for lighter scope.

The CEM120 has a Losmandy-D dovetail saddle plate, as shown in Figure 16. Release the dovetail saddle locking knobs and slide the telescope dovetail plate into the saddle. Tighten the saddle locking knob.

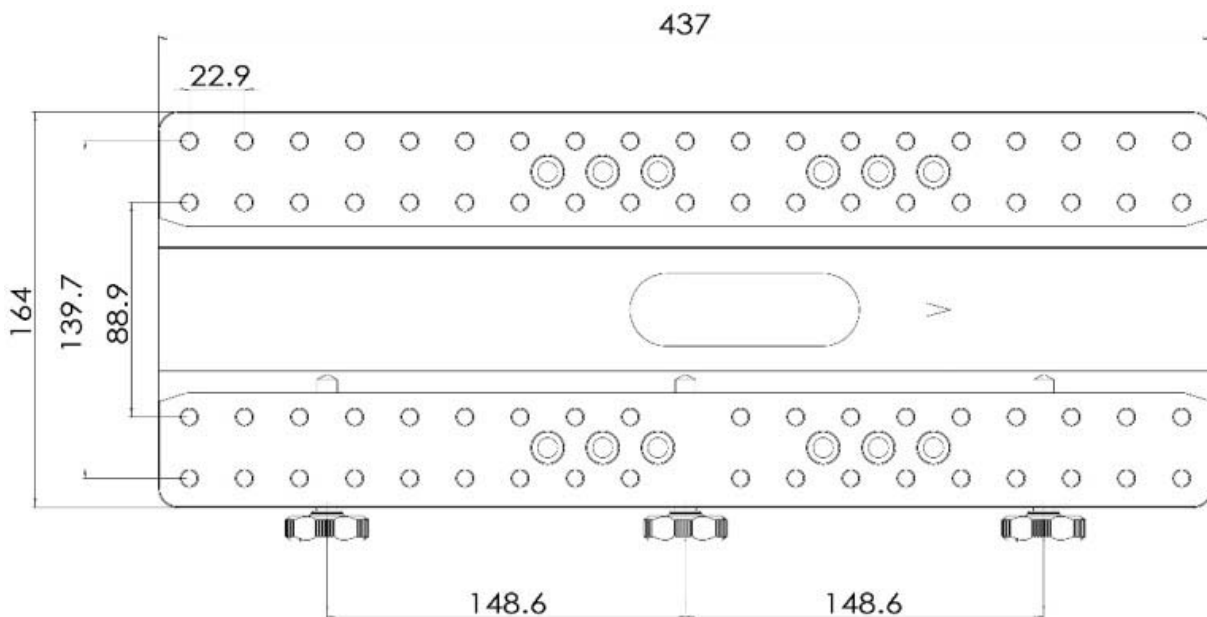

Figure 16. CEM120 dovetail saddle plate

STEP 5. Balance the Payload

After attaching the scope and accessories, the mount head assembly must be balanced in both R.A. and DEC axes to ensure minimum stresses on the mount driving mechanism.

CAUTION: The telescope may swing freely when the R.A. or DEC during the balancing process. Always hold on to the mount and/or telescope assembly before releasing the Axle Locking Knob and/or Gear Switches to prevent it from swinging, which can cause personal injury and/or equipment damage.

With the corresponding Gear Switch disengaged, balance in DEC axis by moving the scope with accessories back and forth in the mount saddle. Balance the assembly in R.A. axis by moving CW along its shaft.

Only balance one axis at a time and start with the DEC axis first. Double check the mount to make sure both the RA and DEC axes are balanced.

Return the mount to the Zero Position after balancing; i.e., the CW shaft points to ground, and the telescope tip is at its highest position.

STEP 6. Connect Cables

Plug in a 12V DC power supply to the DC12V POWER socket; connect the Go2Nova® 8407 Hand Controller to the HBX port on the mount side panel; and install Wi-Fi antenna (right angle one) and GPS antenna, as shown in .

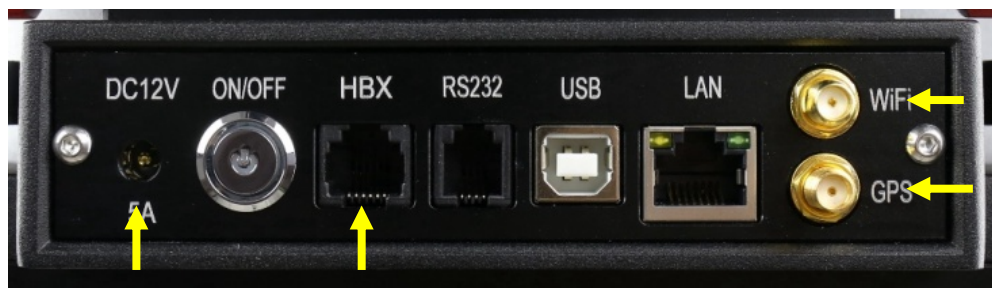

STEP 7. Setup Hand Controller

The CEM120 mount is equipped with a GPS receiver which will receive the UTC time, longitude and latitude information for your current location from satellites after a link is established. However, there are still some parameters which need to be entered to reflect your location, such as time zone information and whether daylight saving time is currently in effect. This information will be stored in the mount until they need be updated.

The GPS with an external antenna should make the mount to connect the satellites in a few minutes. If the GPS module has difficulty receiving the satellite signal, you may manually enter the information.

To set up the controller, press **MENU** => "**Settings**":

```
Select and Slew
Sync. to Target
Alignment
Settings
Electric Focuser
PEC Options
Park Telescope
Edit User Objects
```

Press **ENTER** and select "**Set Time & Site**"

```

Set Time and Site
Beep Settings
Display Settings
Set Guiding Rates
Set Tracking Rate
Set Parking Position
Meridian Treatment
Set Altitude Limit

```

Press **ENTER**. A time and site information screen will be displayed:

```

Daylight Saving Time      Y
UTC -300 Minute(s)
2014-03-09 10:19:18

Longitude:W071°08'50"
Latitude:  N42°30'32"

Northern Hemisphere

```

Set Local Time

The time will be updated automatically when the GPS receiver has established its link with the GPS satellites. In the event that the GPS module is unable to establish a link to the satellites, local time can be entered manually. Use the ◀ or ▶ key to move the cursor █ and use the number keys to change the numbers. Use the ▲ or ▼ button to toggle between “Y” and “N” for Daylight Saving Time, or “+” and “-” for UTC (Coordinated Universal Time) setting. Hold the arrow key to fast forward or rewind the cursor.

In order to make the Hand Controller reflect your correct local time, **time zone information has to be entered**. Press the ◀ or ▶ key, move the cursor to the third line “**UTC -300 Minute(s)**” to set the time zone information (add or subtract 60 minutes per time zone). For example:

- Boston is “UTC -300 minutes”
- Los Angeles is “UTC -480 minutes”
- Rome is “UTC +60 minutes”
- Beijing is “UTC +480 minutes”
- Sydney is “UTC +600 minutes”

All the time zones in North America are “UTC -”, as shown in the following table, so ensure the display shows “**UTC -**” instead of “**UTC +**” if in North or South America.

Time Zone	Hawaii	Alaska	Pacific	Mountain	Central	Eastern
Hour behind UT	-10	-9	-8	-7	-6	-5
Enter UTC	-600	-540	-480	-420	-360	-300

To adjust minutes, move the cursor to each digit and use the number keys to input the number directly. Use ▲ or ▼ key to toggle between “+” and “-”. When the time one information entered is correct, press ENTER and go back to the previous screen. **Note that fractional time zones can be entered.**

Do not manually add or subtract an hour from displayed time to reflect Daylight Saving Time (DST). Only select “Y” after DST begins.

For other parts of the world you can find your “time zone” information from internet.

Set Observation Site Coordinates

The third and fourth lines display the longitude and latitude coordinates respectively. The longitude and latitude coordinates will be automatically updated when the GPS picks up a satellite signal. “W/E” means Western/Eastern Hemisphere; “N/S” means Northern/Southern Hemisphere; “d” means degree; “m” means minute; and “s” means second.

If, for any reason, your GPS does not pick up the satellite signal, you can manually enter your longitude and latitude coordinates. Press the ◀ or ▶ key to move the cursor, use the ▲ or ▼ key to toggle between “W” and “E”, and “N” and “S”, and use the number keys to change the numbers. It is always a good idea to do your homework and get longitude and latitude coordinates before traveling to a new observation site.

The site coordinates information can be found from your smart phone, GPS receiver or via the internet. Site information in decimal format can be converted into d:m:s format by multiplying the decimal numbers by 60. For example, N47.53 can be changed to N47°31'48”:
 $47.53^\circ = 47^\circ + 0.53^\circ$,
 $0.53^\circ = 0.53 \times 60' = 31.8'$, $0.8' = 0.8 \times 60'' = 48''$. Therefore, $47.53^\circ = 47^\circ 31' 48''$ or 47d31m48s.

Select N/S Hemisphere

The Northern/Southern Hemisphere will be selected automatically when the latitude is set, unless the latitude is near the equator. When the latitude is between $-10^\circ \sim +10^\circ$, set it to Northern Hemisphere if the polar axis is pointing to North, or Southern Hemisphere if the polar axis is pointing to South.

STEP 8. Polar Alignment

In order for an equatorial mount to track properly, it has to be accurately polar aligned. A CEM120 mount does not come with an optical polar scope. There are a few ways to perform the polar alignment.

Polar Alignment Software

There are quite a few alignment software available for polar alignment, such as TPoint with The Sky software, PemPro, and Alignmaster

Optional Electronic Polar Scope

A CEM120 has a built-in USB connection (iPolarScope port) for an electronic polar scope. With a proper adapter, an electronic polar scope, such as PoleMaster can be installed onto the mount and ready to use.



Figure 17. CEM120 with an installed electronic polar scope

BrightStar Polar Alignment/Polar Iterate Align

BrightStar Polar Alignment allows you to polar align the mount even if you cannot view the Celestial Pole.

- (1) Level the CEM120 mount and set it at Zero Position. Make sure the telescope is parallel to the pole axis (R.A. axis) of the mount. If a finder scope is used, adjust it to be parallel to the telescope optical axis. Turn the mount power on.
- (2) Pressing **MENU**=>**"Alignment"**=>**"Polar Iterate Align"**. The HC will display the azimuth and altitude position of several bright stars near meridian. Select one that is visible with high altitude as Alignment Star A. Follow the HC instruction to move the Star A to the center of the eyepiece with the combination of Latitude Adjustment Knob and "**◀**" or "**▶**" button. Press **ENTER** to confirm. Next, select a bright star that is close to the horizon as the Alignment Star B. Center it using the Azimuth Adjustment Knob and "**◀**" or "**▶**" button (The "**▲**" and "**▼**" buttons are not used here). Press **ENTER** to confirm.
- (3) The telescope will now slew back to Star A to repeat above steps. The iteration can be stopped when it is determined that the alignment error is at the minimum. Press **BACK** button to exit alignment procedure.

NOTE: The movement of the alignment star in your eyepiece may not be perpendicular but crossed, depends on its location in the sky.

STEP 9. Return Mount to Zero Position

After polar alignment and balancing OTA, return the mount to the Zero Position. The Zero Position is achieved when the CW shaft is pointing towards the ground, with the OTA/dovetail at its highest position, its axis parallel to the polar axis, and the OTA pointing to the Celestial Pole.

Press **MENU** => "**Zero Position**" => "**Goto Zero Position**". When the mount stopped, loosen the DEC and R.A. Gear Switches in turn to adjust the mount to the Zero Position. Engage the clutches after each adjustment. Or press **MENU** => "**Zero Position**" => "**Search Zero Position**" to go to the Zero Position.

Please set the zero position if it is the first time using the mount, or the firmware just being updated. You can always check the Zero Position by using **MENU**=>**"Zero Position"**=>**"Goto Zero Position"** before each session.



Figure 18. Zero Position

4. Getting Started

In order to experience the full GOTO capability of GOTONOVA[®] technology it is very important to set up the mount correctly before observation.

4.1. Setting the Mount and Performing Polar Alignment

Assemble your CEM120 mount according to Section **Error! Reference source not found.** Make sure the mount is leveled. Mount an OTA and accessories, and carefully balance the mount on both R.A. and DEC axes. Turn the mount power switch on. When the GPS receiver is connected to satellites, the hand controller LCD will display GPS OK and the mount will have the correct time and site information (this can also be entered manually as previously described). Polar align the mount.

Always check if the mount is at the Zero Position when the mount is powered on, *i.e.* with the counterweight shaft pointing to ground, OTA at the highest position with its axis parallel to the polar axis and the telescope pointing to the Celestial Pole. Press **MENU => “Zero Position” => “Goto Zero Position”** to check it. If the mount is not at the Zero Position, press **MENU => “Zero Position” => “Set Zero Position.”** Release the Gear Switch to manually return the mount to Zero Position, or use the hand controller to slew the mount to Zero Position. Press **ENTER** to confirm the zero position.

4.2. Manual Operation of the Mount

The mount can now be used to observe astronomical objects using the HC. Use the arrow keys (▶, ◀, ▼, and ▲) to point the telescope to the desired part of the sky. **Use the number keys to change the slewing speed.** Press the **STOP/0** button to start tracking.

4.3. Initial Star Alignment

Perform a simple one star alignment/synchronization after set up the hand controller to correct any pointing discrepancy of the Zero Position and to improve the GOTO accuracy.

To perform “**One Star Align**,” press **MENU=>“Alignment”=>“One Star Align”=>ENTER**. The screen will display a list of bright objects for you to select from. Select an object using ▲ or ▼ key. Then press **ENTER**. After the mount slews to the target, use the arrow keys to center it in your eyepiece. Then press **ENTER**. (More align details in 5.4)

An alternate way is to perform “**Sync to Target**.” Press **MENU=>“Select and Slew”=>ENTER**. Browse over the catalogs and select an object. Press **ENTER**. After the mount slews to the star, press **MENU=>“Sync. To Target”**, follow the on-screen instruction to center the star and press **ENTER**. You may need to use the number keys to change the slewing speed to make the centering procedure easier.

4.4. GOTO the Moon and Other Objects

After performing these set-ups the mount is ready to GOTO and track objects. One of the most common objects is the Moon.

To slew to the Moon press **MENU=>“Select and Slew”=>“Solar System”=>Moon=>ENTER**. The telescope will automatically slew to the Moon and lock on it. It will automatically begin to track once it locks on. If the Moon is not centered in your eyepiece, use the arrow keys to center the Moon. You may use “**Sync to Target**” to improve the tracking.

You may also select other bright celestial objects to start with, such as Jupiter or Saturn.

4.5. Star Identification Function

The 8407+ hand controller has a star identification function. After setting the correct local time and location and completing polar alignment, slew the telescope to a bright star manually or using the GOTO function. Press the Help(?) key to identify the star that the telescope is pointing to, as well as nearby bright stars if there is any.

4.6. Power-Down Memorization

The CEM120 mount can memorize its R.A. and DEC positions if the mount loses its power by accident, even during high speed slewing. After the power is back, just do a **Select and Slew** to the same star when the power is lost. The mount will continue to track the star.

4.7. Turning Off the Mount

When you have finished your observation, simply turn the mount power off and disassemble the mount and tripod.

If the mount is set up on a pier or inside an observatory, it is recommended that you return the mount to the Zero Position or park the telescope. This will ensure that there is no need for you to perform the initial setup again.

5. Complete Functions of Go2Nova® 8407+ Hand Controller

5.1. Select and Slew

Press **MENU** => “**Select and Slew.**” Select an object that you would like to observe and press the **ENTER** key.

The Go2Nova® 8407+ hand controller has a database of over 212,000 objects. Use the ► or ◀ buttons to move the cursor. Use the number buttons to enter a number, or the ▼ or ▲ buttons to change a number. Hold a button to fast scroll through the list. The “◊” symbol indicates that the object is above the horizon, and the “◊̄” symbol means it is below the horizon. In some catalogs the stars below the horizon will not be displayed on the hand controller.

5.1.1. Solar System

There are 9 objects in the Solar System catalog.

5.1.2. Deep Sky Objects

This menu includes objects outside our Solar System such as galaxies, star clusters, quasars, and nebulae.

- Named Objects: consists of 92 popular deep sky objects with their common names. A list of named deep sky objects is included in Appendix E.
- Messier Catalog: consists of all 110 Messier objects.
- NGC Catalog: consists of 7,840 objects.
- IC Catalog: consists of 5,386 objects.
- PGC Catalog: consists of 73,197 objects..
- Caldwell Catalog: consists of 109 objects.
- Abell Catalog: consists of 4,076 objects.
- Herschel Catalog: consists of 400 objects.

5.1.3. Stars

- Named Stars: consists of 259 stars with their common names. They are listed alphabetically; a list is included in Appendix E.
- Double/Multi Stars:: consists of 208 double/multi stars; a list is attached in Appendix E.
- Hipparcos Catalog: the new HIP catalog consists of 120,404 records (2008).

5.1.4. Comets

This catalog contains 15 comets.

5.1.5. Asteroids

This catalog contains 116 asteroids.

5.1.6. Constellations

This catalog consists of 88 modern constellations. They are listed alphabetically; a list is attached in Appendix E.

5.1.7. Custom Objects

This allows the storage of up to 73 user-defined comets, and /or up to 64 stars/DSOs.

5.1.8. Customer R.A. and DEC

Here you can go to a target by entering its R.A. and DEC coordinates.

5.2. Sync to Target

This operation will match the telescope's current coordinates to the Target Right Ascension and Declination. It can be used to correct GOTO pointing error. After slewing to an object, press **MENU** - then scroll to "**Sync to Target**" and press **ENTER**. Follow the screen to perform the sync. Using this function will re-align the telescope to the selected object. Multiple syncs can be performed if needed. This operation is useful to find a faint star or nebula near a bright star.

"**Sync to Target**" will work after "**Select and Slew**" is performed. You can change the slew rate to make the centering procedure easier. Simply press a number (1 through 9) key to change the speed. The default slew rate is 64x.

"**Sync to Target**" will improve the local GOTO accuracy near by the synced star, which is useful for finding a faint object nearby.

5.3. Alignment

This function is used for aligning the telescope to the celestial pole and to create a sky model to calibrate the mount's GOTO[®] functionality.

The hand controller provides a polar alignment via "**Polar Iterate Align**," which uses a set of 2 bright. This also provides a viable polar alignment approach for those who can't see the pole.

The system provides four alignment methods to calibrate the mount's GOTO function: "**Solar System Align**", "**One Star Alignment**", "**Two Star Alignment**" and "**Three Star Alignment**". The "**Two Star Alignment**" may be used to refine the polar alignment.

The mount has to be at Zero Position before performing any alignment.

5.3.1. Position of Polaris/SigmaOct

This function displays the position of the Pole Star. In the Northern Hemisphere the position of Polaris is displayed, while in the Southern Hemisphere the position of Sigma Octantis is shown.

5.3.2. One Star Alignment

Press **MENU** => "**Alignment**" => "**One Star Alignment**." A list of alignment stars that are above the horizon is computed based on your local time and location. With the mount in the Zero Position, use the **▲** and **▼** buttons to select a star and press **ENTER**. Center the target in your eyepiece using the arrow keys. Press **ENTER** when finished. If your mount is set up correctly and polar aligned, one star alignment should be sufficient for good GoTo accuracy. To increase the pointing accuracy over the sky, you may choose to do a three star alignment.

5.3.3. Two Star Alignment

Two Star Align can improve the accuracy of the mount's polar alignment. Press **MENU** => "**Alignment**" => "**Two Star Alignment**" A list of alignment stars that are above the horizon is computed based on your local time and location. With the mount at the Zero Position, use the **▲** and **▼** buttons to select the first alignment star and press **ENTER**. Center the target in your eyepiece using the arrow keys after the mount slews to it. Press **ENTER** when finished. The hand controller will prompt you to choose a second star. After centering the second star, the two-star alignment is finished.

After the two-star alignment, the altitude and azimuth errors will be displayed. This number can be used to fine tune the polar alignment.

For example, if the screen shows 7.5" low and 4.3" east, it means that THE MOUNT axis is pointing low and to the east of the Celestial Pole.

5.3.4. Three Star Alignment

The three-star alignment will further determine the cone error between the OTA and mount axis. The system will use these data to calculate the goto model. If the cone error is big enough, it is suggested to shim the OTA in DEC to minimize it.

Press **MENU** => "**Alignment**" => "**Three Star Alignment.**" A list of alignment stars that are above the horizon is computed based on your local time and location. With the mount at the Zero Position, use the ▲ and ▼ buttons to select the first alignment star and press **ENTER**. Center the target in your eyepiece using the arrow keys. Press **ENTER** when finished. The hand controller will prompt you to choose a second star. Select third star after the mount aligned to the second star.

The system will display the pointing and cone errors after the three star alignment accepted. The system will update the pointing model accordingly.

5.3.5. Solar System Align

This function uses a planet or the moon as an alignment object. Press **MENU** => "**Alignment**" => "**Solar System Align**" for a list of available alignment objects.

5.3.6. Polar Iterate Align

This alignment method allows you to polar align the mount even if you cannot view the Celestial Pole. Press the **MENU** button, then select "**Alignment**" and "**Polar Iterate Align**". The HC will display a list of bright alignment stars near the meridian as Alignment Star A. Follow the HC instructions to move Alignment Star A to the center of the eyepiece using a combination of the Latitude Adjustment Knob and the "◀" and "▶" buttons. Press **ENTER** to confirm the settings. Next, select a bright star that is close to the horizon as Alignment Star B. Center it using the Azimuth Adjustment Knobs and the "◀" and "▶" buttons (*the "▲" and "▼" buttons will not function*). Press **ENTER** to confirm the settings.

The telescope will now slew back to Alignment Star A to repeat the above steps. The iteration can be stopped when it is determined that the alignment error has been minimized. Press the **BACK** button to exit the alignment procedure.

NOTE: It is highly recommended to use an eyepiece with illuminated crosshairs for accurate centering.

NOTE: The movement of the alignment star in your eyepiece may not be perpendicular depending on its location in the sky.

5.3.7. View Model Error

This will display linear RA error, linear DEC error, polar misalignment, non-perpendicular between OTA and DEC, and non-perpendicular between HA and DEC.

5.3.8. Clear Alignment Data

This will clear all alignment data created during one star, two star or three star alignment process. If you are control the mount using planetarium software via ASCOM, and the software has its own alignment function, *please clear the alignment data.*

5.4. Settings

5.4.1. Set Time and Site

Refer to STEP 7 in Section 3.

5.4.2. Beep Settings

The Hand Controller allows a user to turn off the beep partially, or even go to a silent mode. To change this setting press **"MENU =>Settings =>Beep Settings"**,

```
Set Up Time and Site
Beep Settings
Display Settings
Set Guiding Rates
Set Tracking Rate
Set Parking Position
Meridian Treatment
Set Altitude Limit
```

Select one of three available modes:

- **"Always On"** – a beep will be heard on each button operation or mount movement;
- **"On but Keyboard"** – a beep will be heard only when the mount is slewing to the object or there is a warning message;
- **"Always Off"** – all sounds will be turned off, including the SUN warning message.

5.4.3. Display Settings

Press **MENU => "Settings" => "Set Display"**,

```
Set Up Time and Site
Beep Settings
Display Settings
Set Guiding Rates
Set Tracking Rate
Set Parking Position
Meridian Treatment
Set Altitude Limit
```

Use the arrow keys to adjust LCD display contrast, LCD backlight intensity, and keypad's backlight intensity.

5.4.4. Set Guiding Rate

Press **MENU => "Settings" => "Set Guiding Rates"**,

```
Set Up Time and Site
Beep Settings
Display Settings
Set Guiding Rates
Set Tracking Rate
Set Parking Position
Meridian Treatment
Set Altitude Limit
```

This is an advanced function for autoguiding when a guiding camera is utilized either via a Guide Port or using the ASCOM protocol. Before autoguiding, align the polar axis carefully. Select an appropriate guiding speed. The latest firmware allow you to set the R.A. and DEC guiding speed differently. The R.A. guiding speed can be set between $\pm 0.01X$ to $\pm 0.90X$ sidereal rate. The DEC guiding speed can be set between $\pm 0.10X$ to $\pm 0.99X$ sidereal rate. Follow the instructions of your autoguiding software for detailed guiding operation.

The guide port wiring is shown in Figure 4, which has the same pin-out as that from a Celestron / Starlight Xpress / Orion Mount / Orion Autoguider/ QHY5 autoguider.

If you have an autoguider which has the same pin-out as the ST-I from SBIG, such as Meade/ Losmandy/ Takahashi/ Vixen, make sure a proper guiding cable is used. Refer to your guiding camera and guiding software for detailed operation.



WARNING: DO NOT plug your ST-4 guiding camera cable into the iPORT or HBX port. It may damage the mount or guiding camera electronics.

5.4.5. Set Tracking Rate

You can set up the mount tracking rate by selecting “**Set Tracking Rate**”.

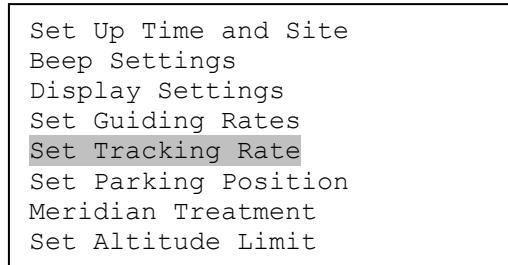

Then the user can select “**Sidereal Rate**”, “**Lunar Rate**”, “**Solar Rate**”, “**King Rate**”, and “**User Defined Speed**”. The “User defined speed” can be adjusted from 0.9900X to 1.0100X of sidereal.

The “King Rate”, developed by Edward S. King, corrects the tracking rate of a telescope to account for atmospheric refraction. This is more useful for unguided tracking.

5.4.6. Set Parking Position

You may park the telescope before powering off the mount. This is very useful if the mount is on a permanent pier or the mount will not be moved in between observation sessions. The mount will keep all the alignment info and reference points.

There are six parking positions. Two positions that park the scope horizontally (**Horizon Position**). Two positions that park the scope vertically (**Zenith Position**). “**Current Position**” will park the scope at its current position. Alternatively, you can enter any altitude and azimuth combination for “**Custom Parking Pos.**”. When the mount is turned on, it will use the last parking position setting as the default setting.

5.4.7. Meridian Treatment

This function tells the mount what to do when it tracks past the meridian. You can tell the mount if it needs a meridian flip and when to do it.

- “**Set Position Limit**” will tell the mount when to stop tracking or to do a meridian flip. The limit can be set at from 0° to 14° (1 hour) pass meridian.
- “**Set Behavior**” will tell the mount if a meridian flip will be performed.

5.4.8. Set Altitude Limit

This function allows the mount to keep tracking an object even if it is below the horizon but can still be seen, for example from an elevated observation site, such as a hill. The range can be set from -89° to +89°. The default limit is 00°. **Be careful when setting this limit.** It may cause mount goto problems.

5.4.9. Enable CW Up Position

This setting will allow the CW moving to a up position. The upward angle limit is same as the meridian flipping setting, or 14 degree at maximum. When this set is enabled, the mount will goto pass the meridian if a object is close to the meridian, within the angle limit. There will be no meridian flip when pass the meridian.

5.4.10. HC Heating Switch

Turn on/off the controller LCD back heater. When “**Heating ON**” is selected, the heater will automatically be turned on when the ambient temperature reaches 0°C (32°F) and shut off at 10°C.

5.4.11. Set RA Guiding

The function is for CEM120EC only. You can turn off R.A. guiding by selecting “**Filter R.A. Guiding**” to allow the high precision encoder to correct the tracking error, or turn the R.A. guiding on by selecting “**Allow RA Guiding**” to allow the mount to receive guiding corrections from the guiding software. The power on default setting is “**Allow RA Guiding**”.

5.4.12. Network Options

This function will display WI-FI and LAN status.

- **Wireless Status:** displays WI-Fi network parameter after a computer/tablet/SmartPhone connected to the mount. The CEM120 network SSID is **HI-LINK_XXXX**, password **12345678**. If the status does not display, select and press **Manual Refresh** to refresh. Here is a example screen after connection:

```
Wlan:AP
SSID:HI-LINK_9E49
IP:192.168.16.254
PORT:8080
MAC:08:EA:40:83:9E:48

Press BACK to exit
```

- **Wired Status:** display LAN parameters after the mount is connected to a network/router. If the status does not display, select and press **Manual Refresh** to refresh. Here is a example screen after connection:

```
ETH:AP
IP:192.168.0.61
PORT:8080
MAC:08:EA:40:83:9E:49

Press BACK to exit
```

- **Manual Refresh:** Refresh mount network parameter after connection.
- **Restart:** restart the network adapter
- **Restore to Factory:** restore the factory network setting

5.4.13. Power LED Switch

Use this setting to keep the mount power indicator (LED) on during the operation, or turn it off automatically after 1 minute

5.4.14. Reset All Settings

Reset all the settings to factory default.

5.4.15. Language

Select one of supported menu languages. Currently has English and Chinese.

5.5. Electric Focuser

This function controls an iOptron electric focuser.

5.6. PEC Option

This function only works for a standard CEM120 mount.

5.6.1. PEC Playback

You can turn “**PEC Playback On**” to improve tracking accuracy which is especially useful for long exposure astrophotography. The default status is “**PEC Playback Off**” when the mount is turned on.

5.6.2. Record PEC

All equatorial mounts have a small variation in the worm gears which may be corrected by using Period Error Correction or PEC. PEC is a system which improves the tracking accuracy of the mount by compensating for variations in the worm gear and is especially useful when doing astrophotography without autoguiding. Because the variations are regular, it is possible to record the corrections required to cancel out the worm gear variations and to play them back to correct the periodic error caused by the variations.

In order to use the PEC function, the Go2Nova[®] hand controller first needs to record the periodic error. The periodic error of the worm gear drive will be used to correct periodic error.

We recommend using a guiding camera to record the PE with autoguiding. Here’s how to use the PEC function:

1. Setup the mount with a telescope in autoguiding configuration by connecting a guiding camera via the mount’s Guide Port or using the ASCOM protocol;
2. Select “**MENU=>Settings => Set Guiding Rates**”. Set a guiding speed from 0.10X to 0.90X. The default setting is 0.25X;
3. Then press the **BACK** button and select “**PEC Option**” from the menu. Use the **▲** and **▼** scroll buttons to display the “**Record PEC**” option and press **ENTER** to start recording the periodic error.
4. It takes the worm gear 240 seconds to make one complete revolution. After 240 seconds PEC will automatically stop recording. The PEC value will be permanently stored inside PEC chip on R.A. motor drive until a new data are recorded.
5. If you want to re-record the periodic error, select “**Record PEC**” and repeat the recording processes again. The previously recorded information will be replaced with the current information.

5.6.3. PEC Data Integrity

This function will check the recorded PEC data integrity.

5.7. Park Telescope

This function parks the scope to one of four preset park positions.

5.8. Edit User Objects

Besides various star lists available in the hand controller, you can add, edit or delete your own user-defined objects. This is especially useful for newly found comets. You can also add your favorite observation object into the user object list for easy sky surfing.

5.8.1. Enter a New Comet

Press “**MENU =>Edit User Objects**” to set user objects.

```
User Defined Comet
Other Objects
```

Select “**User Defined Comet**” to add/browse/delete the user-defined comet list. Find the orbit parameters of a comet in the SkyMap format. For example, the C/2012 ISON has an orbit parameter:

No.	Name	Year	M	Day	q	e	ω	Ω	I	H	G
C/2012	S1 ISON	2013	11	28.7960	0.0125050	1.0000030	345.5088	295.7379	61.8570	6.0	4.0

Select “**Add a New Comet**” to add a new one:

```
Add a New Comet
Browse Comets
Delete a Comet
Delete All Comets
```

The hand controller will display the parameter entry screen:

```
Enter Comet Parameter
Date: 0000-00-00.0000
q: 0.000000
e: 0.000000
 $\omega$ : 000.0000
 $\Omega$ : 000.0000
i: 000.0000
```

Enter the parameters using the arrow buttons and number keys. Press **ENTER** and a confirmation screen will be displayed. Press **ENTER** again to store the object under the assigned user object number, or press **BACK** button to cancel.

5.8.2. Enter Other Objects or Observation List

Press “**MENU =>Edit User Objects**” to set user objects.

```
User Defined Comet
Other Objects
```

Select “**Other Objects**” to enter you own object:

```
Add a New Object
Browse Objects
Delete One Object
Delete All Objects
```

Select **“Add a New Object”**. A screen will be displayed asking you to **Enter R.A. and DEC coordinates**:

```
Enter R.A. and DEC
R.A.: 00h00m00s
DEC: +00d00m00s
```

You may enter the R.A. and DEC coordinates of the object you want to store, and press **ENTER** to confirm.

A more useful application of this function is to store your favorite viewing objects before heading to the field. When the **“Enter R.A. and DEC”** screen appears, press the **MENU** button. It brings up the catalogs that you can select the object from. Follow the screen instructions to add your favorite objects. Press **BACK** button to go back one level.

Press the **BACK** button to go back to the object entry submenu. You may review the records or delete those that are no longer wanted. Press the **BACK** button to finish the operation. Now you can slew to your favorite stars from **“Custom Objects”** catalog using **“Select and Slew.”**

5.9. Firmware Information

This option will display the mount type, firmware version information for the hand controller (HC), Main board (Main), R.A. board (RA), DEC board (DEC) and star catalog.

5.10. Zero Position

5.10.1. Goto Zero Position

This moves your telescope to its Zero Position.

5.10.2. Set Zero Position

This set the Zero Position for the firmware.

The Zero Position reference will be an undefined value after firmware upgrade, or it may lost during power outage or HC battery replacement. You can use this function to set the zero position reference.

Press the **ENTER** after moving the mount to Zero Position either manually or with the hand controller.

5.10.3. Search Zero Pos.

In the event of power failure, the mount will lose all its alignment information. This can be very troublesome if the mount is being operated from a remote observation site and is controlled via the internet. To counter this, the CEM120 has been equipped with a function that can find the Zero Position for an initial mount set up.

Select **“Search Zero Pos.”** and the mount will start to slew slowly and find the R.A. and DEC position to set the mount to the Zero Position. When the mount has found the Zero Position, the HC will ask if you want to calibrate the Zero Position. Press **ENTER** to confirm. The mount will then provide a list of bright stars for you to perform alignment. This will correct any discrepancy in the Zero Position. Alternatively, press **BACK** to cancel.

6. Maintenance and Servicing

6.1. Maintenance

The CEM120 mount is designed to be maintenance free. Do not overload the mount. Do not drop the mount as this will damage the mount and / or permanently degrade GoTo performance and tracking accuracy. Use a wet cloth to clean the mount and hand controller. Do not use solvent.

If your mount is not to be used for an extended period, dismount the OTAs and counterweight(s).

6.2. iOptron Customer Service

If you have any question concerning your CEM120 mount contact iOptron Customer Service Department. Customer Service hours are from 9:00 AM to 5:00 PM, Eastern Time, Monday through Friday. In the event that the CEM120 requires factory servicing or repairing, write or call iOptron Customer Service Department first to receive an RMA# before returning the mount to the factory. Please provide details as to the nature of the problem as well as your name, address, e-mail address, purchase information and daytime telephone number. We have found that most problems can be resolved by e-mails or telephone calls, so please contact iOptron first to avoid returning the mount for repair.

It is strongly suggested that to send technical questions to support@ioptron.com. Call in the U.S. 1.781.569.0200.

6.3. Product End of Life Disposal Instructions



This electronic product is subject to disposal and recycling regulations that vary by country and region. It is your responsibility to recycle your electronic equipment per your local environmental laws and regulations to ensure that it will be recycled in a manner that protects human health and the environment. To find out where you can drop off your waste equipment for recycling, please contact your local waste recycle/disposal service or the product representative.

6.4. Battery Replacement and Disposal Instructions



Battery Disposal: Batteries contain chemicals that, if released, may affect the environment and human health. Batteries should be collected separately for recycling, and recycled at a local hazardous material disposal location adhering to your country and local government regulations. To find out where you can drop off your waste battery for recycling, please contact your local waste disposal service or the product representative.

Appendix A. Technical Specifications

Mount	Center-balanced Equatorial Mount (CEM)
Payload	52kg (115 lbs), exclude counterweight*
Mount weight	26kg (57 lbs)
Payload/Mount weight ratio	2
Material	All metal
Latitude adjustment range	0°~ 68° (0.5 arcmin division)**
Azimuth adjustment range	± 5° (3 arcmin division)
Right Ascension worm wheel	Φ216mm, 360 teeth, zero backlash
Declination worm wheel	Φ216mm, 360 teeth, zero backlash
Worm	Φ26mm
PEC	PPEC/Real time PEC
PE	~±3.5 arcsec p-p (#7300) or <0.15 arcsec RMS for 5 min (#7301)
Worm period	240 sec
Counterweight shaft	Φ 38, 540 mm (SS, anti-slip, 4.5kg)
Counterweight	10 kg (22 lbs)
Mount base size	210 x 230 mm
Motor drive	Stepper motor
Resolution	0.07 arc seconds
Slew speed	1x,2x,8x,16x,64x,128x,256x,512x,MAX(~4°/sec)
Power consumption	0.7A(Tracking), 1.8A(GOTO)
Power requirement	12V DC 5A
AC adapter	100V ~ 240V (included)
Polar scope	Optional electronic polar scope
Hand Controller	Go2Nova® 8407+,212,000+ objects database, star recognition
Meridian treatment	Stop (0-14° pass), auto flip
Zero position	Automatic zero search
Park position	Horizontal, vertical, current, alt/azi input
Level indicator	Yes
Dovetail saddle	Losmandy D, 17.2" (437mm)
GPS	Yes
Autoguide port	ST-4
Communication port	RS232, USB, LAN, Wi-Fi
PC computer control	Yes (ASCOM)
Cable management	2xDC12V (1A), DC5V(1A), 2xDC (5A), ST4, 6P6C, 4xUSB2.0, USB3.0 (powered), USB for PS, AUX
Operation temperature	-10°C ~ +40°C
Pier/tripod	Optional Pier
Warranty	Two year limited

*These are only guidelines. Some telescopes are very long or very big for their weight and may require a larger mount. Remember also that imaging requirements are more rigid than visual observation.

**For latitude below 10°, a special CW shaft mounting house is needed.

Appendix B. Go2Nova[®] 8407+ HC MENU STRUCTURE

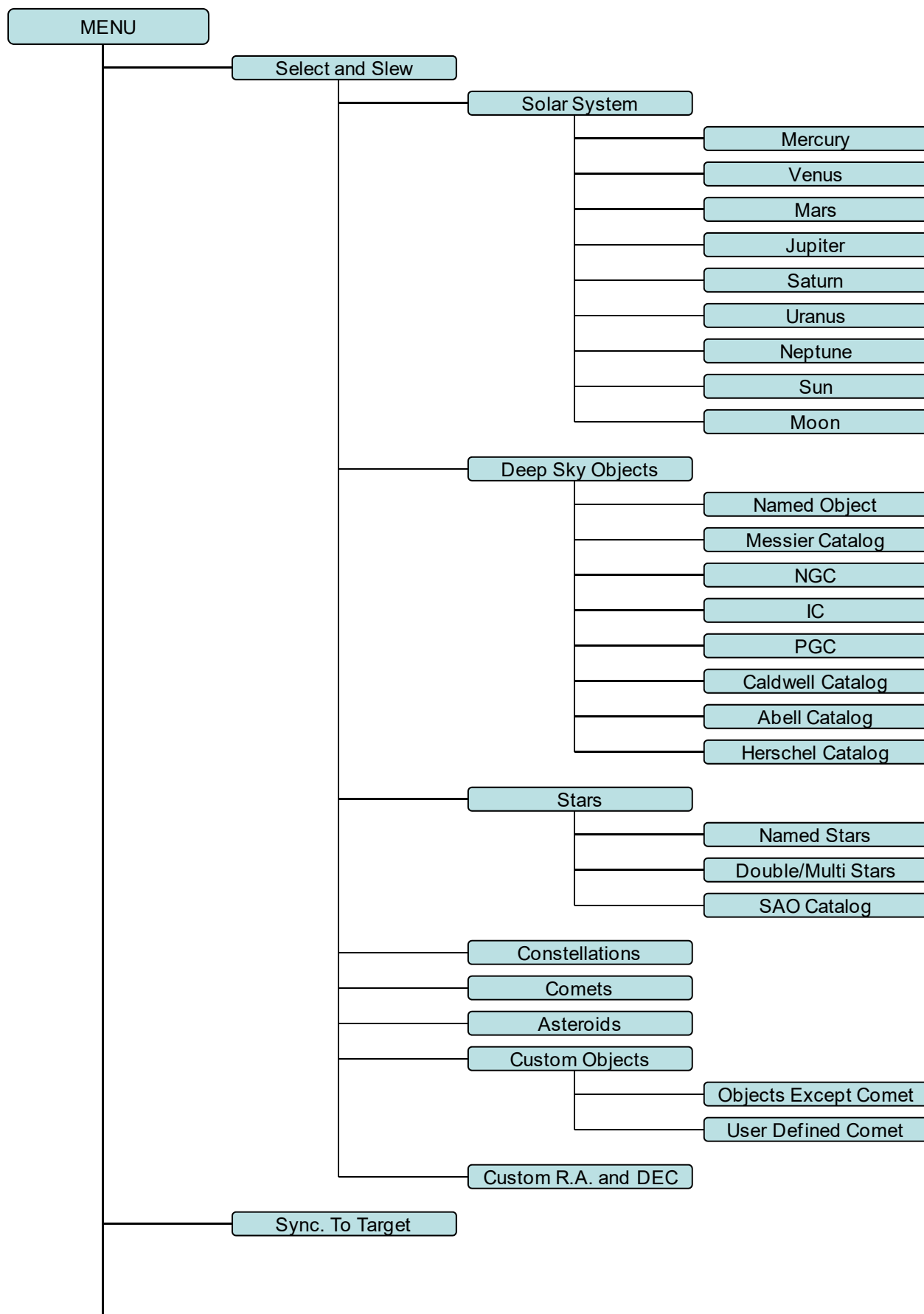

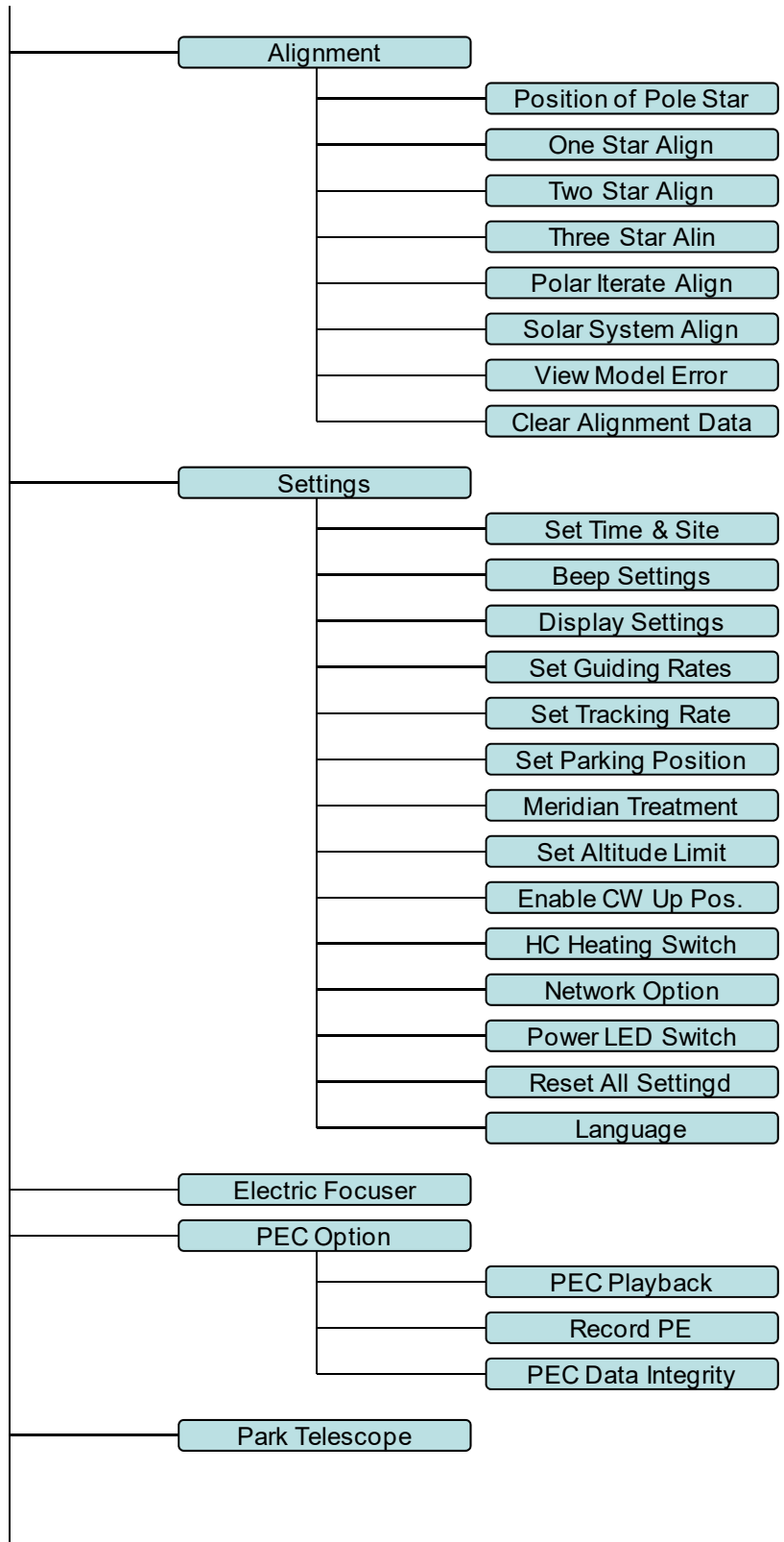

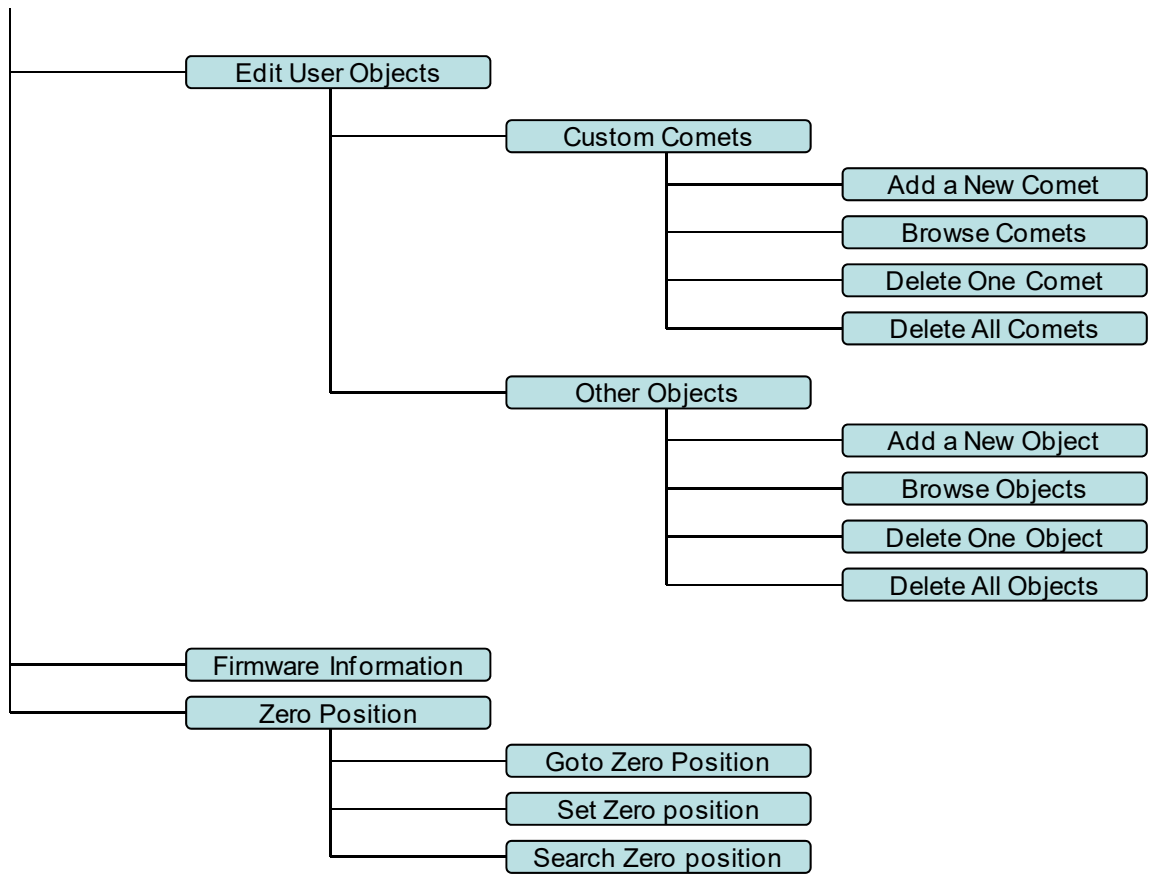

Appendix C. Firmware Upgrade

The firmware in the 8407+ Hand Controller and control boards can be upgraded by the customer. Please check iOptron's website, www.iOptron.com, under Support Directory/CEM Mounts, select CEM120 for details.

Appendix D. Computer Control a CEM120 Mount

The CEM120 mount can be connected to a computer, a tablet, and/or a SmartPhonebe via serial, USB, LAN or WI-Fi connection.

Please refer to iOptron website, www.iOptron.com, under Support Directory/ASCOM Driver, iOptron Telescope ASCOM Driver, for more details.

Appendix E. Go2Nova[®] Star List

Named Deep Sky Object

1	47 Tucanae	47	Integral Sign Galaxy
2	Andromeda Galaxy	48	Iris Nebula
3	Antennae Galaxies	49	Jellyfish Nebula
4	Barnard's Galaxy	50	Jewel Box Cluster
5	Bear-Paw Galaxy	51	Lagoon Nebula
6	Beehive Cluster	52	Lambda Centauri Nebula
7	Black Eye Galaxy	53	Large Magellanic Cloud
8	Blinking Planetary	54	Leo Triplet
9	Blue Flash Nebula	55	Little Dumbbell Nebula
10	Blue Planetary	56	Little Gem Nebula
11	Blue Snowball Nebula	57	Little Ghost Nebula
12	Bode's Galaxy	58	Mice Galaxies
13	Box Nebula	59	Monkey Head Nebula
14	Bubble Nebula	60	North America Nebula
15	Bug Nebula	61	Northern Jewel Box
16	Butterfly Cluster	62	Omega Nebula
17	Butterfly Galaxies	63	Orion Nebula
18	California Nebula	64	Owl Nebula
19	Carina Nebula	65	Pacman Nebula
20	Cat's Eye Nebula	66	Pelican Nebula
21	Cave Nebula	67	Phantom Streak Nebula
22	Christmas Tree Cluster	68	Pinwheel Galaxy
23	Cigar Galaxy	69	Pleiades
24	Cocoon Nebula	70	Ring Nebula
25	Coma Pinwheel	71	Rosette Nebula
26	Copeland Septet	72	Saturn Nebula
27	Crab Nebula	73	Sextans B
28	Crescent Nebula	74	Small Magellanic Cloud
29	Draco Dwarf Galaxy	75	Sombrero Galaxy
30	Dumbbell Nebula	76	Soul Nebula
31	Eagle Nebula	77	Southern Pinwheel Galaxy
32	Eight-Burst Nebula	78	Spindle Galaxy(3115)
33	Elephant Trunk Nebula	79	Spindle Galaxy(5866)
34	Eskimo Nebula	80	Stephan's Quintet
35	Eyes Galaxies	81	Sunflower Galaxy
36	Flame Nebula	82	Tarantula Nebula
37	Flaming Star Nebula	83	The Witch Head Nebula
38	Ghost of Jupiter	84	The Wizard Nebula
39	Heart Nebula	85	Thor's Helmet
40	Helix Nebula	86	Triangulum Galaxy
41	Hercules Globular Cluster	87	Trifid Nebula
42	Hind's Variable Nebula	88	Ursa Minor Dwarf Galaxy
43	Hockey Stick Galaxies	89	Veil Nebula
44	Horsehead Nebula	90	Whale Galaxy
45	Hubble's Variable Nebula	91	Whirlpool Galaxy
46	Hyades Cluster	92	Wild Duck Cluster

Messier Catalog

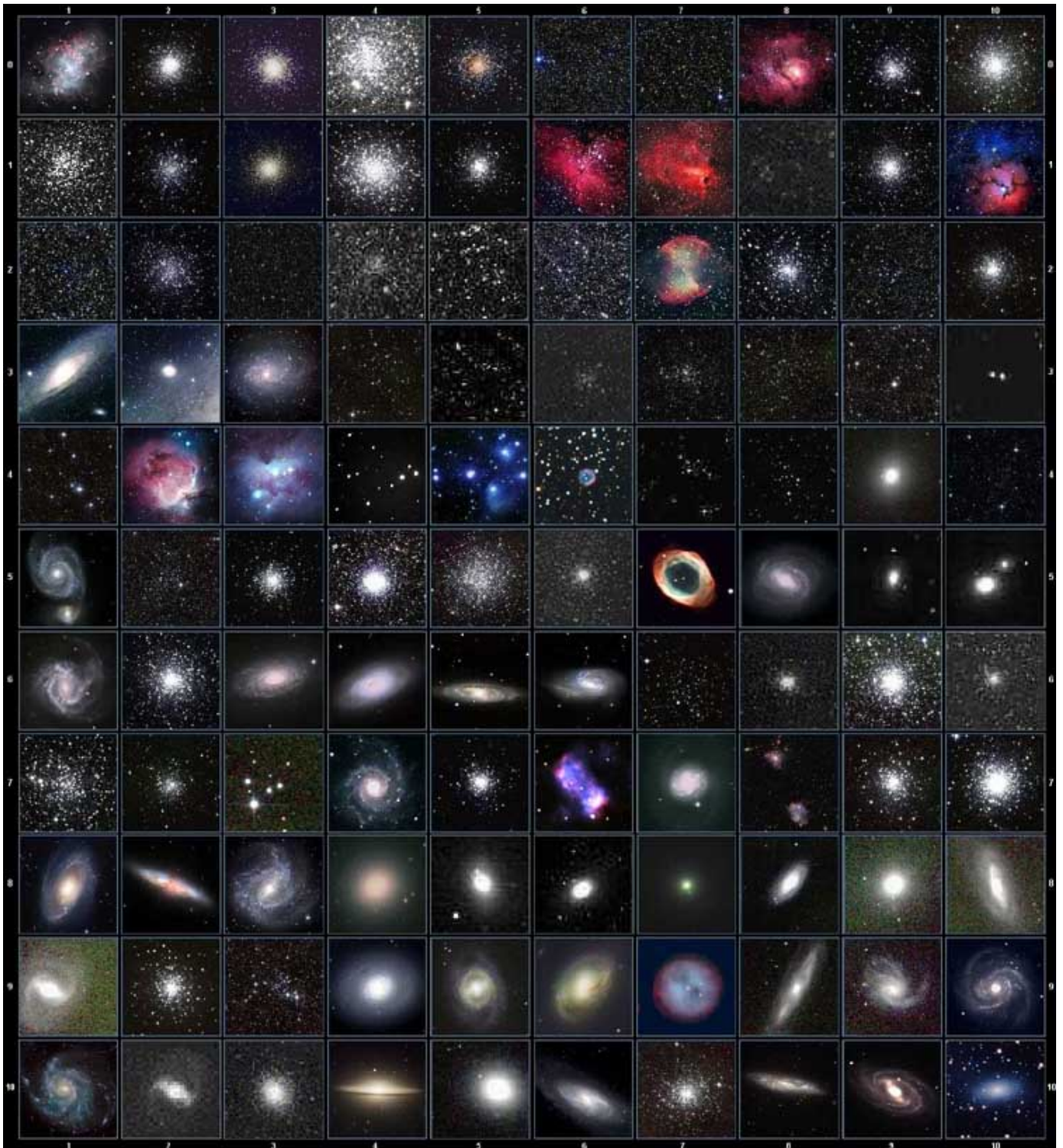

This table is licensed under the [GNU Free Documentation License](#). It uses material from the [Wikipedia article List of Messier objects](#)

Named Stars

1	Acamar	50	Alrescha	99	Deneb el Okab	148	Lalande 21185
2	Achernar	51	Alshain	100	Deneb Kaitos	149	Lesath
3	Achird	52	Altair	101	Denebakrab	150	Mahasim
4	Acrab	53	Altais	102	Denebola	151	Maia
5	Acrux A	54	Alterf	103	Dschubba	152	Marfik
6	Acrux B	55	Aludra	104	Dubhe	153	Marfikent
7	Acubens	56	Alula Australis	105	Edasich	154	Markab
8	Adhafera	57	Alula Borealis	106	El Rehla	155	Markeb
9	Adhara	58	Alya	107	Electra	156	Matar
10	Adid Australis	59	Ancha	108	Elnath	157	Mebсутa
11	Ahadi	60	Ankaa	109	Eltanin	158	Megrez
12	Al Dhanab	61	Antares	110	Enif	159	Meissa
13	Al Dhibain Prior	62	Apollyon	111	Errai	160	Mekbuda
14	Al Kab	63	Arcturus	112	Fomalhaut	161	Menkalinan
15	Al Nair	64	Arkab Prior	113	Furud	162	Menkar
16	Al Nair al Baten	65	Arneb	114	Gacrux	163	Menkent
17	Al Niyat(Sigma)	66	Ascella	115	Gatria	164	Menkib
18	Al Niyat(Tau)	67	Asellus Australis	116	Giausar	165	Merak
19	Albaldah	68	Asellus Borealis	117	Gienah Corvi	166	Merope
20	Albali	69	Aspidiske	118	Gienah Cygni	167	Mesartim
21	Albireo	70	Atik	119	Girtab	168	Miaplacidus
22	Alchiba	71	Atlas	120	Gliese 1	169	Mimosa
23	Alcor	72	Atria	121	Gomeisa	170	Mintaka
24	Alcyone	73	Avior	122	Graffias(Zeta)	171	Mira
25	Aldebaran	74	Azha	123	Groombridge 1830	172	Mirach
26	Alderamin	75	Barnard's Star	124	Gruid	173	Mirfak
27	Alfirk	76	Baten Kaitos	125	Grumium	174	Mirzam
28	Algenib	77	Beid	126	Hadar	175	Mizar
29	Algenubi	78	Bellatrix	127	Hamal	176	Mu Velorum
30	Algieba	79	Beta Hydri	128	Han	177	Muhlifain
31	Algiedi Secunda	80	Betelgeuse	129	Hatsya	178	Muphrid
32	Algol	81	Betria	130	Head of Hydrus	179	Muscida
33	Algorab	82	Biham	131	Homam	180	Naos
34	Alhakim	83	Birdun	132	Iritjinga(Cen)	181	Nashira
35	Alhena	84	Canopus	133	Izar	182	Navi
36	Alioth	85	Capella	134	Kakkab Su-gub Gud-Elim	183	Nekkar
37	Alkaid	86	Caph	135	Kapteyn's Star	184	Nihal
38	Alkalurops	87	Castor A	136	Kaus Australis	185	Nunki
39	Alkes	88	Castor B	137	Kaus Borealis	186	Nusakan
40	Almaaz	89	Cebalrai	138	Kaus Media	187	Palida
41	Almach	90	Chara	139	Keid	188	Peacock
42	Alnasl	91	Chertan	140	Kekouan	189	Phact
43	Alnilam	92	Choo	141	Kitalpha	190	Phecda
44	Alnitak	93	Cor Caroli	142	Kochab	191	Pherkad
45	Alpha Muscae	94	Cursa	143	Koo She	192	Polaris
46	Alpha Tucanae	95	Dabih	144	Kornephoros	193	Pollux
47	Alphard	96	Deltotum	145	Kraz	194	Porrima
48	Alphecca	97	Deneb	146	Kurhah	195	Procyon
49	Alpheratz	98	Deneb Algedi	147	Lacaille 9352	196	Propus

197	Proxima Centauri	213	Sadalbari	229	Sulafat	245	Vindemiatrix
198	Rasalas	214	Sadalmelik	230	Syrma	246	Vrischika
199	Rasalgethi	215	Sadalsuud	231	Talitha	247	Wasat
200	Rasalhague	216	Sadr	232	Tania Australis	248	Wazn
201	Rastaban	217	Saiph	233	Tania Borealis	249	Wei
202	Regor	218	Sargas	234	Tarazed	250	Wezen
203	Regulus	219	Scheat	235	Taygeta	251	Yed Posterior
204	Rigel	220	Schedar	236	Tejat Posterior	252	Yed Prior
205	Rigel Kentaurus A	221	Seginus	237	Thuban	253	Zaniah
206	Rigel Kentaurus B	222	Shaula	238	Thusia	254	Zaurak
207	Ruchbah	223	Sheliak	239	Tien Kwan	255	Zavijava
208	Rukbat	224	Sheratan	240	Turais	256	Zeta Persei
209	Rukh	225	Sirius	241	Unukalhai	257	Zosma
210	Rutilicus	226	Skat	242	Vasat-ul-cemre	258	Zubenelgenubi
211	Sabik	227	Spica	243	Vathorz Posterior	259	Zubeneschamali
212	Sadachbia	228	Suhail	244	Vega		

Modern Constellations

No.	Constellation	Abbreviation
1	Andromeda	And
2	Antlia	Ant
3	Apus	Aps
4	Aquarius	Aqr
5	Aquila	Aql
6	Ara	Ara
7	Aries	Ari
8	Auriga	Aur
9	Boötes	Boo
10	Caelum	Cae
11	Camelopardalis	Cam
12	Cancer	Cnc
13	Canes Venatici	CVn
14	Canis Major	CMa
15	Canis Minor	CMi
16	Capricornus	Cap
17	Carina	Car
18	Cassiopeia	Cas
19	Centaurus	Cen
20	Cepheus	Cep
21	Cetus	Cet
22	Chamaeleon	Cha
23	Circinus	Cir
24	Columba	Col
25	Coma Berenices	Com
26	Corona Australis	CrA
27	Corona Borealis	CrB
28	Corvus	Crv
29	Crater	Crt
30	Crux	Cru
31	Cygnus	Cyg
32	Delphinus	Del
33	Dorado	Dor
34	Draco	Dra
35	Equuleus	Equ
36	Eridanus	Eri
37	Fornax	For
38	Gemini	Gem
39	Grus	Gru
40	Hercules	Her
41	Horologium	Hor
42	Hydra	Hya
43	Hydrus	Hyi
44	Indus	Ind

No.	Constellation	Abbreviation
45	Lacerta	Lac
46	Leo	Leo
47	Leo Minor	LMi
48	Lepus	Lep
49	Libra	Lib
50	Lupus	Lup
51	Lynx	Lyn
52	Lyra	Lyr
53	Mensa	Men
54	Microscopium	Mic
55	Monoceros	Mon
56	Musca	Mus
57	Norma	Nor
58	Octans	Oct
59	Ophiuchus	Oph
60	Orion	Ori
61	Pavo	Pav
62	Pegasus	Peg
63	Perseus	Per
64	Phoenix	Phe
65	Pictor	Pic
66	Pisces	Psc
67	Piscis Austrinus	PsA
68	Puppis	Pup
69	Pyxis	Pyx
70	Reticulum	Ret
71	Sagitta	Sge
72	Sagittarius	Sgr
73	Scorpius	Sco
74	Sculptor	Scl
75	Scutum	Sct
76	Serpens	Ser
77	Sextans	Sex
78	Taurus	Tau
79	Telescopium	Tel
80	Triangulum	Tri
81	Triangulum Australe	TrA
82	Tucana	Tuc
83	Ursa Major	UMa
84	Ursa Minor	UMi
85	Vela	Vel
86	Virgo	Vir
87	Volans	Vol
88	Vulpecula	Vul

Double/Multi Stars

1	RigelKentaurus A	53	HIP 95771	105	HIP 40167	157	HIP 28790
2	Rigel	54	HIP 30867	106	HIP 40817	158	HIP 4675
3	Gacrux	55	HIP 35363	107	HIP 81292	159	HIP 31676
4	Sargas	56	HIP 94761	108	HIP 80197	160	HIP 10176
5	Castor A	57	HIP 21683	109	HIP 88060	161	HIP 25950
6	Mizar	58	HIP 8497	110	HIP 42637	162	HIP 117931
7	Almach	59	HIP 26199	111	HIP 21039	163	HIP 81914
8	Algieba	60	HIP 104521	112	HIP 100965	164	HIP 21242
9	Aludra	61	HIP 116389	113	HIP 25768	165	HIP 86831
10	Iritjinga(Cen)	62	HIP 17797	114	HIP 93717	166	HIP 115272
11	Zubenelgenubi	63	HIP 21036	115	HIP 79980	167	HIP 46657
12	Alcyone	64	HIP 107310	116	HIP 12086	168	HIP 41404
13	Cor Caroli	65	HIP 72659	117	HIP 90968	169	HIP 29388
14	Acamar	66	HIP 21029	118	HIP 22531	170	HIP 49321
15	Adhafera	67	HIP 42726	119	HIP 34065	171	HIP 84054
16	Rasalgethi	68	HIP 18255	120	HIP 79607	172	HIP 39035
17	Meissa	69	HIP 9153	121	HIP 109786	173	HIP 25303
18	Graffias(Zeta)	70	HIP 88267	122	HIP 56280	174	HIP 52520
19	Alya	71	HIP 85829	123	HIP 51561	175	HIP 95398
20	HIP 48002	72	HIP 43937	124	HIP 107930	176	UCAC4 277-135548
21	HIP 95947	73	HIP 71762	125	HIP 97966	177	HIP 32609
22	HIP 20894	74	HIP 80047	126	HIP 117218	178	HIP 101765
23	HIP 74395	75	HIP 58484	127	HIP 82676	179	HIP 24825
24	HIP 27072	76	HIP 25142	128	HIP 111546	180	HIP 31158
25	HIP 26549	77	HIP 54204	129	HIP 29151	181	HIP 3885
26	HIP 85667	78	HIP 76669	130	HIP 107253	182	HIP 93371
27	HIP 74376	79	HIP 99770	131	HIP 88136	183	HIP 36345
28	HIP 34481	80	HIP 101027	132	HIP 81702	184	HIP 108364
29	HIP 53253	81	HIP 74911	133	HIP 97423	185	HIP 50939
30	HIP 99675	82	HIP 35210	134	HIP 30444	186	HIP 76603
31	HIP 63003	83	HIP 26235	135	HIP 66400	187	HIP 32269
32	HIP 43103	84	HIP 40321	136	HIP 17579	188	HIP 42516
33	HIP 110991	85	HIP 70327	137	HIP 35785	189	HIP 62807
34	HIP 20635	86	HIP 26221	138	HIP 81641	190	UCAC4 226-128246
35	HIP 88601	87	HIP 80473	139	HIP 7751	191	HIP 94913
36	HIP 2484	88	HIP 78105	140	HIP 21148	192	HIP 94336
37	HIP 91971	89	HIP 79043	141	HIP 9021	193	HIP 107299
38	HIP 79374	90	HIP 61418	142	HIP 97816	194	HIP 59984
39	HIP 102532	91	HIP 91919	143	HIP 88818	195	HIP 16411
40	HIP 52154	92	HIP 41639	144	HIP 36817	196	HIP 23287
41	HIP 37229	93	HIP 104214	145	HIP 25695	197	HIP 105637
42	HIP 30419	94	HIP 23734	146	HIP 98819	198	HIP 108925
43	HIP 108917	95	HIP 60189	147	HIP 61910	199	HIP 103814
44	HIP 53417	96	HIP 66821	148	HIP 111643	200	HIP 58112
45	HIP 65271	97	HIP 14043	149	HIP 80399	201	HIP 109354
46	HIP 67669	98	HIP 5737	150	HIP 83478	202	HIP 43822
47	HIP 105319	99	HIP 84626	151	HIP 101123	203	HIP 21986
48	HIP 80582	100	HIP 60904	152	HIP 28271	204	HIP 17470
49	HIP 8832	101	HIP 58684	153	HIP 64246	205	HIP 35960
50	HIP 69483	102	HIP 5131	154	HIP 96895	206	HIP 42936
51	HIP 92946	103	HIP 115126	155	HIP 35564	207	HIP 19272
52	HIP 86614	104	HIP 62572	156	HIP 37843	208	HIP 76143

IOPTRON TWO YEAR TELESCOPE, MOUNT, AND CONTROLLER WARRANTY

A. iOptron warrants your telescope, mount, or controller to be free from defects in materials and workmanship for two years. iOptron will repair or replace such product or part which, upon inspection by iOptron, is found to be defective in materials or workmanship. As a condition to the obligation of iOptron to repair or replace such product, the product must be returned to iOptron together with proof-of-purchase satisfactory to iOptron.

B. The Proper Return Merchant Authorization Number must be obtained from iOptron in advance of return. Call iOptron at 1.781.569.0200 to receive the RMA number to be displayed on the outside of your shipping container.

All returns must be accompanied by a written statement stating the name, address, and daytime telephone number of the owner, together with a brief description of any claimed defects. Parts or product for which replacement is made shall become the property of iOptron.

The customer shall be responsible for all costs of transportation and insurance, both to and from the factory of iOptron, and shall be required to pre-pay such costs.

iOptron shall use reasonable efforts to repair or replace any telescope, mount, or controller covered by this warranty within thirty days of receipt. In the event repair or replacement shall require more than thirty days, iOptron shall notify the customer accordingly. iOptron reserves the right to replace any product which has been discontinued from its product line with a new product of comparable value and function.

This warranty shall be void and of no force of effect in the event a covered product has been modified in design or function, or subjected to abuse, misuse, mishandling or unauthorized repair. Further, product malfunction or deterioration due to normal wear is not covered by this warranty.

IOPTRON DISCLAIMS ANY WARRANTIES, EXPRESS OR IMPLIED, WHETHER OF MERCHANTABILITY OF FITNESS FOR A PARTICULAR USE, EXCEPT AS EXPRESSLY SET FORTH HERE. THE SOLE OBLIGATION OF IOPTRON UNDER THIS LIMITED WARRANTY SHALL BE TO REPAIR OR REPLACE THE COVERED PRODUCT, IN ACCORDANCE WITH THE TERMS SET FORTH HERE. IOPTRON EXPRESSLY DISCLAIMS ANY LOST PROFITS, GENERAL, SPECIAL, INDIRECT OR CONSEQUENTIAL DAMAGES WHICH MAY RESULT FROM BREACH OF ANY WARRANTY, OR ARISING OUT OF THE USE OR INABILITY TO USE ANY IOPTRON PRODUCT. ANY WARRANTIES WHICH ARE IMPLIED AND WHICH CANNOT BE DISCLAIMED SHALL BE LIMITED IN DURATION TO A TERM OF TWO YEARS FROM THE DATE OF ORIGINAL RETAIL PURCHASE.

Some states do not allow the exclusion or limitation of incidental or consequential damages or limitation on how long an implied warranty lasts, so the above limitations and exclusions may not apply to you.

This warranty gives you specific legal rights, and you may also have other rights which vary from state to state.

iOptron reserves the right to modify or discontinue, without prior notice to you, any model or style telescope.

If warranty problems arise, or if you need assistance in using your telescope, mount, or controller contact:

iOptron Corporation
Customer Service Department
6E Gill Street
Woburn, MA01801
www.ioptron.com
support@ioptron.com
Tel. (781)569-0200
Fax. (781)935-2860
Monday-Friday 9AM-5PM EST

NOTE: This warranty is valid to U.S.A. and Canadian customers who have purchased this product from an authorized iOptron dealer in the U.S.A. or Canada or directly from iOptron. Warranty outside the U.S.A. and Canada is valid only to customers who purchased from an iOptron Distributor or Authorized iOptron Dealer in the specific country. Please contact them for any warranty.