

ZWO-AM5

User Manual



Table of Contents

Preface

Tips

Included Items

1. Product Introduction

2. Performance Parameters

3. How to Use

3.1 Introduction to the Equatorial Mount

3.2 Mounting the Equatorial Mount

3.2 AM5 Mount Installation

3.2.1 Body installation

3.2.2 Handle Controller Connection

3.2.3 Installation of height -increasing section (optional)

3.2.4 Counterweight (optional) Installation

3.2.5 ASI AIR (optional) installation -----OLD DESIGN

3.3 Use of Equatorial Mount

3.3.1 How to adjust the pitch angle from the first gear to the second gear?

3.3.2 How to adjust the azimuth?

3.3.3 How to switch the equatorial mode to alt-azimuth mode?

3.4 How to Connect the Computer to Control the Equatorial Mount?

3.5 How to Use ASI AIR to Control the Equatorial Mount?

4. Structural Dimensions

5. After Sales

6. Warranty

Preface

Thank you for purchasing the ZWO AM5 Strain Wave Gear Mount. (Hereinafter referred to as AM5)

After years of research, ZWO has developed the new AM5 with its customized strain wave gears to meet the desire of the modern astrophotographer for a mount with low periodic error, accurate tracking and high torque in a small and portable unit.

The AM5 is built using the latest Computer Aided Design and Manufacturing (CAD/CAM) techniques, with a modern industrial design interface combined with the aircraft grade aluminum which keeps a good balance between portability and reliability. The internal structure of the mount body is optimized with the harmonic drive speed reducer and synchronous belt, bringing accurate control with an amazing reduction ratio of 300:1. To ensure the quality, ZWO also measures each mount and equip it with the exclusive PE curve before it proudly leaves our factory. With your purchase, you can rest assured knowing that you will receive a top-of-the-line product, service and support.

ZWO AM5 software is compatible with ASIAIR, ASCOM, INDI and other platforms.

The purpose of this manual is to support the user in the operation of the AM5 mount. Please read this manual carefully before using your AM5 and follow the instructions carefully.

Any equipment damage or personal injury caused by improper operation are the responsibility of the user.

The AM5 design, associated software and operating features are the intellectual property of ZWO and may not be reproduced without permission.

Tips

Before Using the AM5 Mount, Please Read the Following Tips Carefully and Follow the Instructions In This Manual During Use.

1. When using the AM5, DO NOT directly observe or image the sun with naked eyes through telescopes or finder glasses, without using specially designed solar filters. This will cause permanent and irreversible damage to the observer's eyes, and potentially damage property and equipment or create a fire hazard.
2. Carefully select a suitable tripod according to the size and weight of your telescope and determine if a counterweight is required. The use of heavy loads without a counterweight installed may cause the tripod and telescope to tip over. Always test the center of gravity of the telescope in all directions prior to use to avoid the mount from falling and causing equipment damage or personal injury.
3. After use, set the mount to the home position, and power down the mount. Failure to follow this step may cause the home position to be inaccurate at the next start up and the use of the GOTO function at this point may cause equipment damage or personal injury. If the mount is not at home position at start up, return the mount to its home position immediately after power up and before use of any GOTO command. Normal operation can commence when the mount is at the home position.

4. Do not allow children to touch or use the mount unsupervised to avoid accidental rollovers or personal injury. Small parts are included with this mount which may also cause suffocation or other injuries to children.
5. Do not use or store the mount in a humid and salty environment. Corrosion may occur causing damage or impairment of the mount accuracy .
6. Do not use corrosive cleaning products on the mount as these may damage the surface finish. Exposure to the sun for long periods of time may cause discoloration or fading of the finish to occur.
7. Do not attempt to disassemble the mount. Damage may occur which reduces its accuracy or damage it beyond repair. Disassembly may also cause personal injury to the user.
8. The AM5 mount is a precision instrument. Please handle it with care to avoid damage to the mount and impair its accuracy.
9. The operational temperature of the AM5 mount is -15°C to 40°C , please do not use the mount outside this temperature range. Doing so may cause the equipment to operate abnormally, or may cause equipment damage.

Included Items



- | | | |
|--------------------|-------------------------|-----------------------------|
| 1. Case | 4. Performance Sheet | 7. 2m Hand Controller Cable |
| 2. AM5 mount body | 5. Quick Guide Brochure | 8. M6 Allen key |
| 3. 2m USB2.0 cable | 6. Hand Controller | 9. M4 Allen key |

1. Product Introduction

Released by ZWO for its 10th anniversary, the AM5 features high performance strain wave gears creating a precision and intelligent light weight mount built to meet the demands of modern astronomers.

Key Features:

- 1. High Precision:** The AM5 Strain Wave Gear Mount is equipped with a special harmonic reducer achieve high-precision control. The Periodic Error (PE) is stable within ± 20 arcseconds and offers a high torque output allowing the use of large loads without the need for a counterweight. Each mount includes a chart of its own individual PE error curve.
- 2. High Load:** the AM5 body weighs 5.5kg. It can carry a payload of up to 13kg without counterweight. This is increased to 20 kg if an optional counterweight is used.
- 3. Customized Control System:** The mount is features a highly customized control software with over the air (OTA) upgrade capability.
- 4. Dual Mode:** The AM5 mount is capable of both equatorial and alt-azimuth modes making it suitable for both visual and imaging. use
- 5. No Restrictions On Areas of Use:** The AM5 is designed with an elevation angle of 0-90 degrees and can be used anywhere from the equator to the polar regions.
- 6. Physical Hand Controller + APP Control:** The AM5 can be controlled via the included hand controller or, for a modern feel, via mobile phone or tablet using our AM5 app. The app offers an onscreen joystick combined with the convenient tools such as Best Objects of the Evening, a built in star map with real-time display and GOTO functions. There is no need to connect to a computer, the mount and hand controller connect via WiFi.

Other advantages:

- 1. Wide Range of Tripod Options:** Users may choose from the matching TC40 carbon fiber tripod or use an existing tripod. The mount is compatible with tripods from various manufacturers.
- 2. Fully Sealed Gearbox Design:** prevents the strain wave gear from corrosion and maintains a consistent performance.
- 3. In Built Home Position Finder:** Users may find home by use of the single key GOTO home feature which uses a mechanical sensor.
- 4. Power-off Braking:** In the event of power failure, brakes are instantly applied to prevent the telescope and equipment from falling and resulting in damage or injury.
- 5. Seamless Connectivity:** The AM5 offers a wide variety of connection possibilities. Users may command the AM5 via the ASI AIR for the ultimate in modern mount control using a cable or WiFi connection. For ASCOM/INDI users, the AM5 connects to your astronomy software via our free ASCOM/INDI drivers, allowing the seamless use of other astronomy software.

2.Performance Parameters

Equatorial Mode Style	German Equatorial Mount
Available Modes	Equatorial or Alt-Azimuth
Transfer Method	Strain Wave Gear + synchronous belt (300:1 reduction ratio)
PE Cycle Error	$<\pm 20''$
PE Cycle Time	432s
RA Drive	Type 42 stepper motor + Type 17 100 reduction ratio harmonic gear with inbuilt brake
DEC Drive	Type 35 stepper motor + Type 17 100 reduction ratio harmonic gear
Load Capacity	13kg (without counterweight) 20kg (with counterweight)
Body Weight	5.5kg
Latitude Adjustment Range	0°-90°
Azimuth Adjustment Range	$\pm 10^\circ$
Saddle Style	Losmandy & Vixen dual dovetail saddle
Counterweight Thread	M12 *1.75 coarse teeth
Motor Resolution	0.17''
Maximum Speed	6°/S
Rotation Speed	0.5x, 1x, 2x, 4x, 8x, 20x, 60x, 720x, 1400x
Power Input Interface	DC 5.5-2.1 (12V $\geq 3A$)
Power Output Interface	DC 5.5-2.1 (12V $\leq 5 A$)
Power Consumption	Standby: 12V@0.4A Tracking: 12V@0.6A GOTO: 12V@1.7A
Guide Interface	ST4
Communication Interfaces	USB / WiFi
Home Sensor Style	Mechanical zero position
Operating Temperature	-15°C to 40°C
Power-off Brake	RA Axis Only

3. How to use

3.1 Introduction to the Equatorial Mode



- ①. **Finder Slot Mounting Holes:** can be used to install the finder foot
- ②. **Power Switch:** Turn the mount power on or off.
- ③. **Counterweight Screw Hole:** Unscrew the cover to connect the optional 12mm threaded counterweight bar and counterweight.
- ④. **Pitch Angle Gear Adjustment Screw:** A screw is located on either side of the main body. Loosen these with a hexagonal wrench, and the pitch can be adjusted between 0-90 degrees.
- ⑤. **Azimuth Lock:** Loosen it if you want to adjust Azimuth scale, or tighten it if you want to fasten the Azimuth scale.
- ⑥. **Dovetail Slots:** Suitable for both Losmandy and Vixen style dovetails.
- ⑦. **Pitch Angle Scale:** range 0~90°
- ⑧. **Pitch Angle Tensioner:** Loosen the knob to adjust the pitch angle, and tighten it after completion.
- ⑨. **Bubble Levels:** Displays whether the mount body is level.
- ⑩. **Pitch Angle Fine-Tuning Knob:** Rotate the equatorial mount clockwise to pitch up, and counterclockwise to pitch down.
- ⑪. **Azimuth Fine-Tuning Knobs:** Rotate the knobs on both sides to adjust the azimuth base.



- ⑫. **Dovetail Clamp Knobs:** Adjust the dovetail slot width using the two knobs. Lock the knobs tightly to prevent slippage.
- ⑬. **12V Power Output Port:** Supplied from the main body power socket, this outlet can supply power to devices such as ASI AIR.
- ⑭. **Finder Foot:** Can be used to install ASI AIR, laser stylus, finder or guidescope and other equipment.

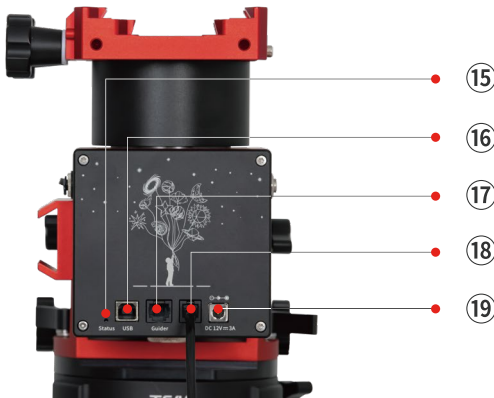

- ⑮. **Mode Indicator:** A red light is displayed for Equatorial mount mode, a green light is displayed for Alt-Azimuth mode (if the mount has no synchronization, the indicator light flashes alternately red and green, and the corresponding color indicator light will be displayed according to the mode after synchronization).

- ⑩. **USB Socket:** (USB2) Connects the AM5 to devices that support USB interface such as computer control via ASI/AIR, ASCOM/INDI or PC to support mount upgrades to firmware.
- ⑪. **ST4 Guide Interface:** Hardware guiding can be provided through the inbuilt ST4 guide port.
- ⑫. **Physical HC Interface:** connects the mount hand controller.
- ⑬. **Power Input Port:** DC 12V input, 5.5-2.1mm. It is recommended that the power supply capacity of the adapter be at least 3 A or more. When the voltage is lower than 10V, the buzzer inside the mount will beep to alert the user to a low voltage situation.

Power Output Port: It can supply power to other 12V devices. Maximum current is 5 Amps.

2. An introduction to the features of AM5 hand controller

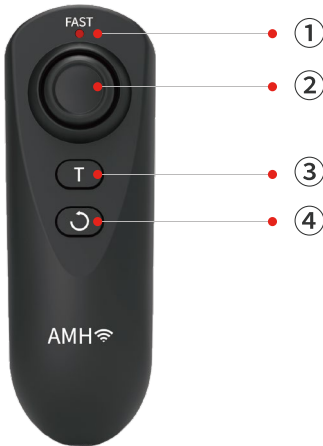

- ①. **Light Indicator:** It indicates HIGH or LOW sidereal tracking rate the mount currently is in. When the light is on, it means the mount is in high tracking rate.
- ②. **Directional Control Joystick:** The joystick can be used to slew the two axis. Pressing down on the joystick knob switches between high and low slew speeds. There are 1, 2, 4, 8 x sidereal rate at low speed, 20 to 1440 x sidereal rate at high speed. Slew speeds are infinitely variable through joystick, light touches create slow speeds and pushing the joystick right over, slews at max rate.
- ③. **Tracking Button:** Click to enable or disable tracking.
- ④. **Cancel Button:** Click to cancel the current function, such as cancel GOTO, and long press (3 seconds) to GOTO Home position.

Cancel: One press to cancel GOTO or other functions.

Long press the cancel button for 3 seconds to go to zero position.

Equatorial/Azimuth Mode Switching: When the power for mount is off, long press the cancel button to activate the mount again along with the switch function. To enter Azimuth mode, do not loosen your finger from the cancel button until the light indicator turns green. (How to identify the current mode of the mount: It's in Equatorial mode if the light indicator displays red after boot; in Azimuth mode if the light indicator displays green.)

WiFi: If you forget the hand controllers WiFi password, you can press and hold the Tracking and Cancel buttons together for 5 seconds. The high-speed indicator light will flash and the hand controller WiFi password will be restored to the default setting: 12345678 .



Scan to watch
operating video

3. AM5 Mount Installation

3.2.1 Body Installation

*Tripod model: ZWO carbon fiber TC40

1. Extend the Tripod.



2. Secure the Installation Disk. Use a hexagonal wrench to attach 3 x M6 screws to fix the mounting plate on the main body of the AM5.

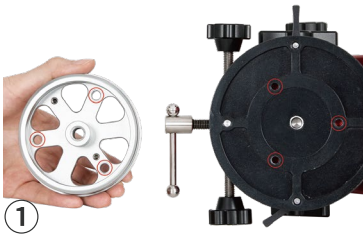

3. Install the Body On the Tripod. Place the main body of the mount on the tripod, install the threaded tension bolt (as shown in Figure 1 below), and turn the knob clockwise to lock it.

4. Install the Triangular Spreader Plate and Turn the Knob Clockwise to Lock It.

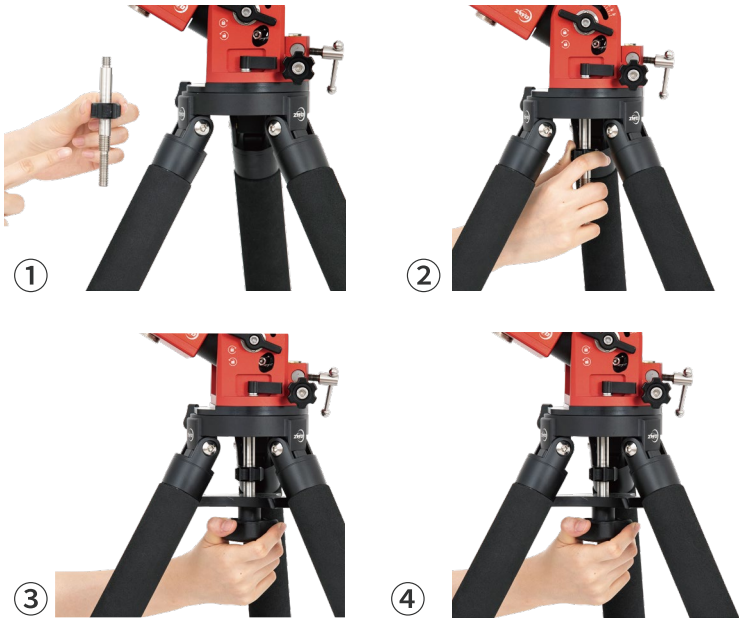

Scan to watch operating video

3.2.2 Handle Controller Connection

Use the coiled cable to connect the hand controller to the AM5 mount body.



3.2.3 Installation of Pier Section (Optional)

1. First, take 3 x M6 socket head screws to fix the first pier section on the body of the AM5 mount.

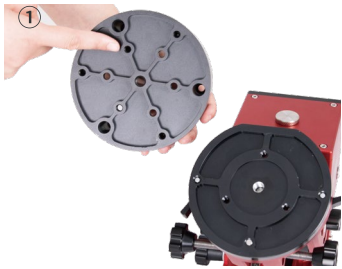

2. Then use 3 socket head cap screws to fix the second pier section onto the first section, and then install the mounting plate.

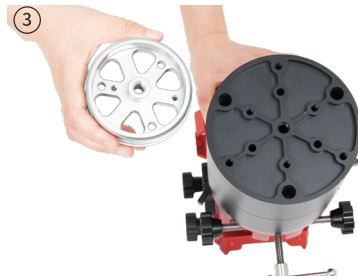
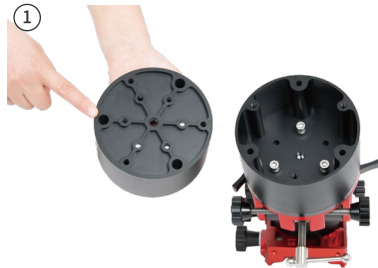

3. Finally, install the assembled body and mount on the tripod as normal.



3.2.4 Optional Counterweight Installation

Choosing Whether to Install a Counter Weight

If the combined weight of the telescope is less than 13kg there is no requirement to have a counterweight installed. If the combined weight of the telescope reaches 13kg or more, a counterweight should be used.

The total weight of the telescope should not exceed 20kg.

In order to ensure the stability of the equipment, it is recommended to use a counterweight when the total weight of the telescope reaches 10kg.

Counter weight Installation Steps

1. Find the mounting screw hole for the counterweight at the bottom of the AM5 mount body. The screw hole will have a silver color plug in.
2. Turn the plug counterclockwise until fully unscrewed.
3. Install the counterweight bar and tighten clockwise, then install the weight.



3.2.5 ASI AIR (Optional) Installation -----OLD DESIGN

Remove or buy a finder mirror slot and put it on the side of the dovetail slot, A SIAIR can be installed on the side of the dovetail slot or on the main mirror



3.3 Use of Equatorial Mode

3.3.1 How to Adjust the Pitch Angle Range

The pitch angle adjustment of the equatorial mount AM5 is divided into two ranges, the first gear pitch angle range allows operation from 0~60°; the second pitch angle range covers 45°~90°.

When the mount is in the first range, the pitch adjustment angle is limited to 60°. To reach more than 60° you will need to use a hex wrench to loosen the lock screws on both sides of the main body, and then turn the equatorial mount to the alternative pitch range (45° position). After completion, tighten the screws on both sides, and continue to adjust the Pitch Angle Fine-Tuning Knob to 90°.



Latitude scale 0°



Latitude scale 90°

To Change the Pitch Angle From 0° to 90° for Alt-azimuth Use, the Steps are as Follows:

1. Loosen the pitch angle tensioner on both sides and turn the pitch angle fine-tuning knob clockwise so the hex screw pitch angle gear adjustment screw is completely visible from the hole.



2. Use a hex wrench to fully loosen the lock screws on both sides.

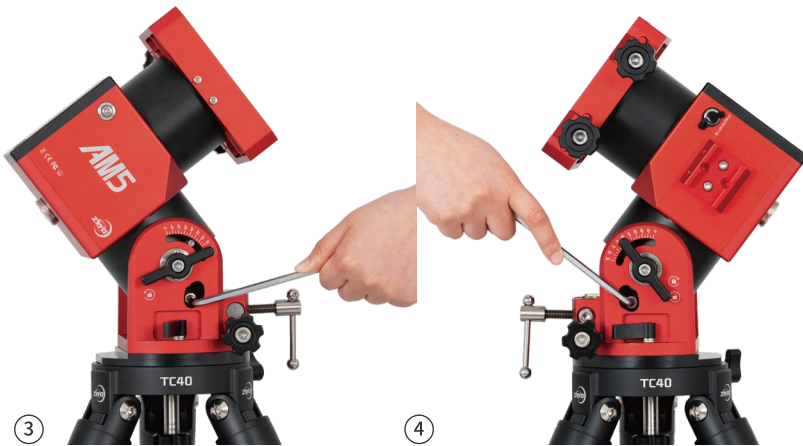

Scan to watch operating video

3、 Move the AM5 body to slide the pitch angle gear adjustment screw so the hex screw slides to the bottom end of the slide rail in the hole, the scale screw will indicate 45°, and the hex screw is exposed at the same time. Tighten the hex screw on both sides.



4. Continue to rotate the pitch angle fine-tuning knob clockwise to adjust the pitch angle to the 90° position, and then tighten the [pitch angle tensioner].



3.3.2 How to Adjust the Azimuth Angle

Loosen the azimuth locking levers, turn the azimuth angle fine-tuning knobs, and adjust to the required azimuth angle. Once completed, lock the azimuth locking levers.



3.3.3 How to Switch Between Equatorial and Alt-azimuth Modes

The indicator light is red for equatorial mount mode, and the indicator light is green for alt-azimuth mode.

Using the Hand Controller to Change Modes

Tip: Before Switching Modes, Turn Off the Mount Power Button

Step 1: Adjust the pitch angle to 90 degrees (refer to 3.3.1 for the steps);

Step 2: Connect the hand controller, press and hold the Cancel Button while turning on the AMS mount power. The indicator light turns red (or from green to red), release the Cancel Button to enter the chosen mount mode

How to switch to Equatorial mode from Azimuth mode: Make sure the hand controller is connected to the mount, then long press the cancel button to boot the mount. Don't loosen your finger until the light indicator turns red. The mount is in Equatorial mode now.

Note: After the mount is switched to another mode, if the light indicator remains the color of the current mode for 5 seconds then flashes red and green in turn, it means you need to connect the mount to ASI AIR, or AM5 APP, or any other astrophotography software in your laptop to sync the local time and coordinate information. After synchronization, the light indicator will get back to normal status.



Scan to watch operating video

2. Changing the Mode Via the Mobile Device:

Download the AM5 APP on your mobile phone in advance.

Adjust the elevation angle of the equatorial mount to 90 degrees (refer to 3.3.1 for the steps) turn on the mount power, open the AM5 app on the mobile device and connect to the controller hotspot. The WIFI name format is: AMH_*****, and the default password is: 12345678.

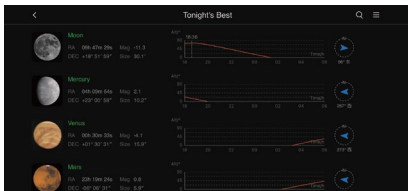
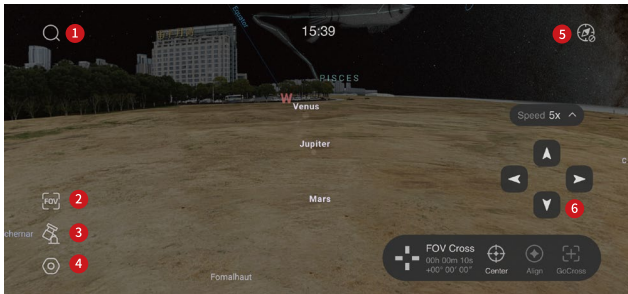

Best GOTO target interface of the night

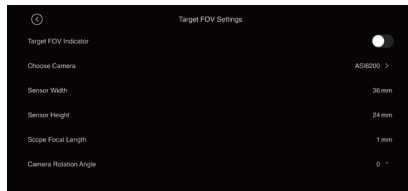

Field of view setting interface

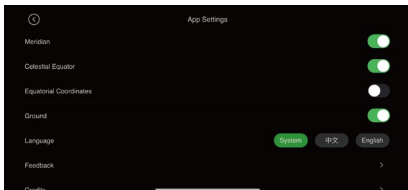

APPsetting interface

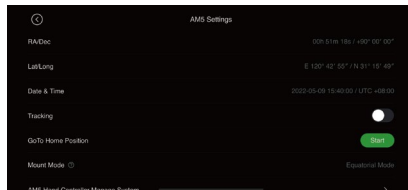

Equator setting interface

- ① **Magnifying Glass:** Best tonight, choose the target, with the function of GOTO.
- ② **Box FOV:** Click to set the field of view.
- ③ **Equatorial:** View the information of the mount, as well as the functions of [Tracking], [EQ or AZALMode] (the default is equatorial mount mode when this mode is turned off), and GOTO home [Zero].
- ④ **Hexagon:** App setting, allowing you to configure the meridian, celestial equator, coordinates, languages, etc.
- ⑤ **Compass:** Compass positioning.
- ⑥ **On Screen Joystick:** Controls the two axis (equipped with five kinds of speed) .

Note: In Azimuth mode when you install the telescope on mount, keep the objective pointing at your left side, like the figure shown below. Also keep the tension knob of the dovetail saddle plate upwards when the Azimuth mount is parked at zero position. If the telescope is installed in the wrong direction, the GOTO and tracking results will also get wrong.

Correct Installation Method:



Wrong Installation Method:



3.4 Computer Connection to the AM5 Mount

Preparation: Connect the mount to the power supply, and use the ZWO USB2.0 data cable to connect the USB port on the mount to the USB interface on the computer.

2. Open the official website <http://zwoasi.com/software>, select [Technical Support] > [Software].

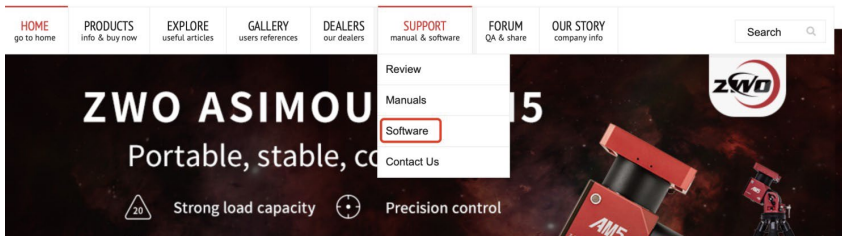

3. Click to download [ASCOM driver (optional)]---ASCOM platform①, and then download the ASCOM driver②.

ASCOM Drivers (optional)				
ASCOM Platform	<p>After installing the ASCOM Platform, please install below ASCOM drivers, then you can use many 3rd party astro software through ASCOM.</p> <p>Note: This software is not from ZWO, we just provide another download node. Official Site</p> <p>Note: To connect the AM5 mount to your computer, make sure you've downloaded and installed Microsoft .NET Framework 3.5</p>	v6.5	Released 11/20/2020 1	Download
ASCOM	ASCOM driver to support ASI Cameras, EAF, EFW and USBST4.	v6.5.2 Change Log	Released 2 3/11/2022	Download Last Ver

4. After the download is complete, double-click to install the ASCOM platform and ASCOM driver, and complete the operation according to the prompts.

5. Install the application software that supports ASCOM driver, such as: Maxim DL, NINA, SGP, etc., can control the AM5 equatorial mount. Select ASIMount ① under the corresponding software equatorial mount, then click [Properties.] ②, a new dialog box will pop up.

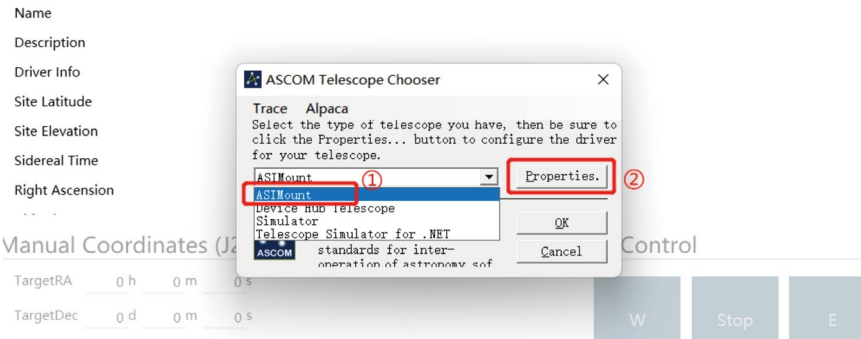

5.1 Click the drop-down menu button ① in the new window, select an interface* ②, and then click [Connect] ③ to connect the mount and the computer.

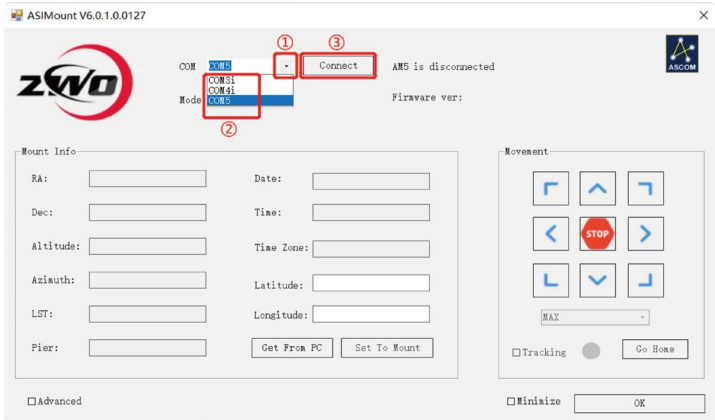

*Note: The selected interface serial number can be found in the computer management, as shown in the figure below; you can also try to connect one by one.

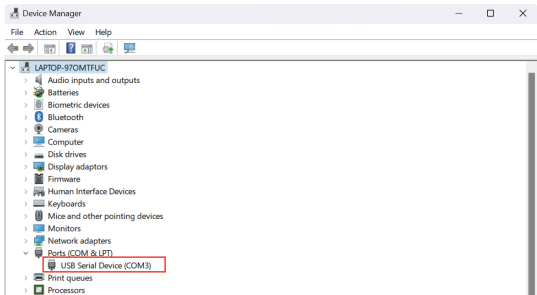

5.2 The connection is successful! Press and hold the slew direction buttons to control the movement of the mount.

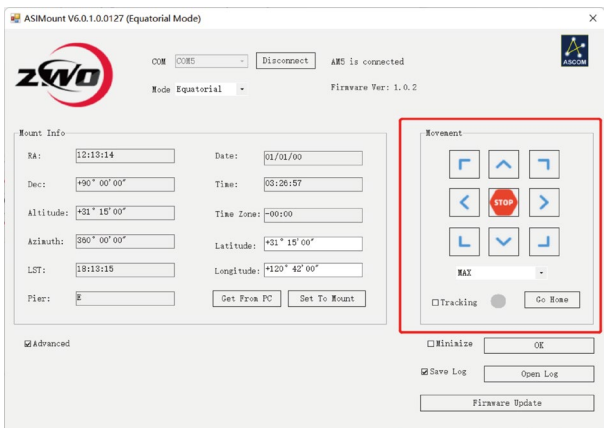

3.5 How to Use ASI AIR to Control the Equatorial Mount?

3.5.1 Fix the ASI AIR on the mount body finder foot, or to the telescope using its own finder foot

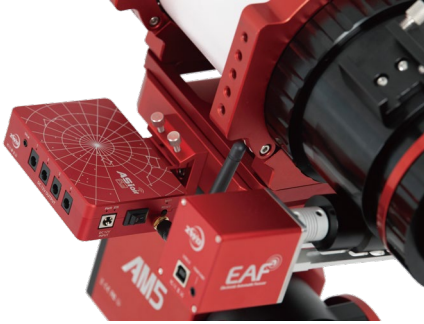

3.5.2 After the whole system is powered on, select the corresponding ASI AIR wireless signal in the wireless LAN of the mobile phone

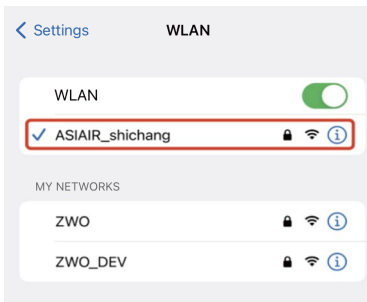

3.5.3 Open the ASI AIR APP to enter the equatorial mount selection page, select OnStep beta, (Should be AM5 Mount) and then click the button to start the application. The serial port will show that it is connected, and the parameters of the corresponding equatorial mount will be displayed on the page.

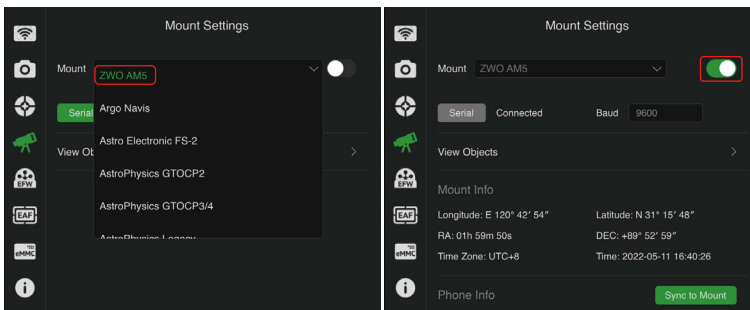

3.5.4 Return to the main page of the APP to set or turn on each device, you can control the equatorial mount through ASI AIR

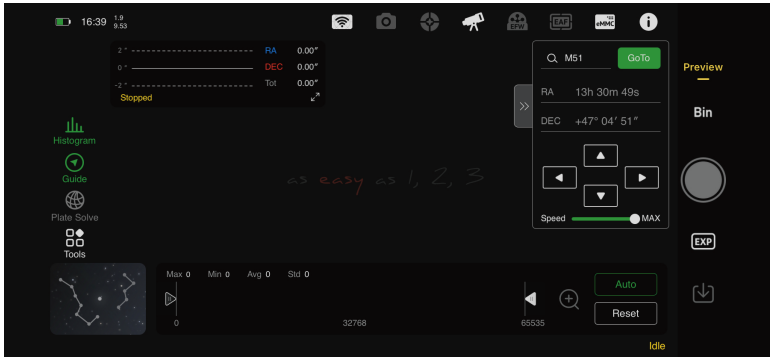

4 Structural Dimensions

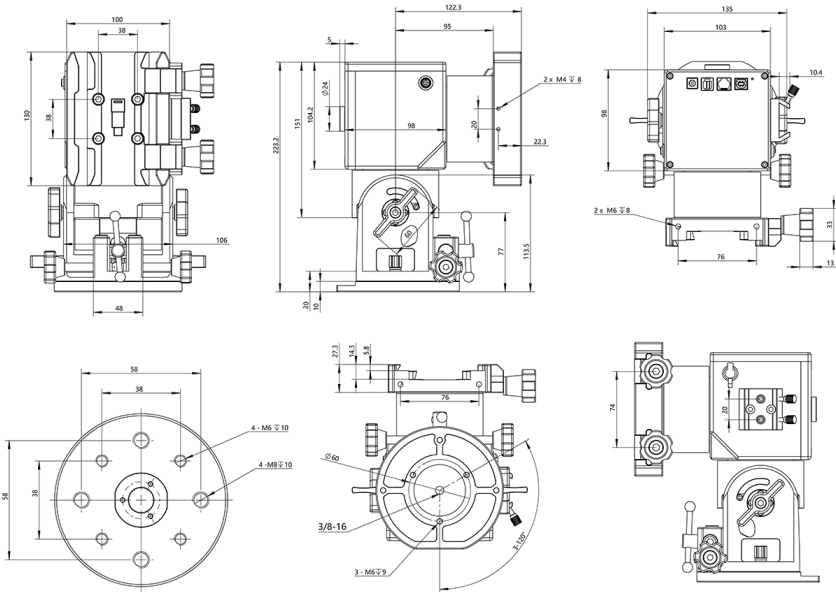

Unit: mm

5 After sales

For software update, please directly head over to the ZWO website [Main page – Support - Software].

For maintenance and other service, please contact us at:

<https://support.astronomy-imaging-camera.com/>

Submit your problems on this page. Our customer service will help!

Email: info@zwoptical.com

Phone: 0086-0512-65923102

1. For the normal repair or replacement of the Products during the Warranty Period, the User will bear the return cost. When returning the Products, Users shall specify the actual reasons for the damage to the Products, and shall provide the corresponding valid certificates, such as pictures or videos, etc.

For the Products that need to be replaced after being confirmed by ZWO in writing, the User shall return the Products with the complete package, together with all accessories, manuals, etc., to the address designated by ZWO.

By sending back the product to ZWO, the User agrees to pay out-of-warranty fees that may arise during the repair process of the product. ZWO will send back the product after charging.

2. If a User encounters any problem during the use of ZWO Products, you may at any time contact ZWO for technical support via ZWO Support.

For the Products that need to be returned for after-sales service, ZWO will provide the corresponding RMA code for reference.

ZWO will not accept any products having no RMA code that have been returned privately without ZWO written confirmation.

3. If a User purchases the ZWO Products from a ZWO agent, the User may contact the ZWO agent directly for the relevant after-sales service.

6 Warranty

1. ZWO will provide a 2-year free warranty service (Warranty Period) for ZWO products purchased by Users from ZWO (“Products”) in accordance with this Policy, commencing on the day following receipt of the Products by Users. For AM5 users, commencing on the day of device activation.

2. If a User encounters the following Dead on Arrival (DOA) and contacts ZWO within the corresponding time limit to issue the Product purchase invoice and relevant evidence, ZWO will provide door-to-door pick-up service and, as appropriate, after-sale replacement (or partial replacement), repair or return (or partial return) service for the following Products:

1) Product quality problem

Provided that a User detects a quality problem and contacts ZWO within 30 days after receipt of the Products, and ZWO support team confirms that the Products indeed have a quality problem or defect after their inspection, ZWO will provide free replacement service towards such Products;

2) Product transportation problem

Provided that a User finds obvious signs of bubbling, serious overstocking, or deformation on the outer package of the Products upon receipt of the Products, and provides ZWO with pictures of the outer package and proof of receipt within 3 days after receipt of such Products, ZWO support team will verify the actual shipper and determine the responsible party for such transportation problem. In the event that ZWO is the actual shipper, ZWO will be responsible for providing the relevant return or replacement service, however, if the Products are directly sold or transported to the User by an agent of ZWO, the agent will be responsible for providing the relevant return or replacement service.

3. If the Products are under the following circumstances, they are not within the scope of warranty service, ZWO may provide maintenance services to the Users:

- 1) The Warranty Period of the Products has expired; or
- 2) The Products are injected into liquid or affected by moisture or corrosion; or
- 3) The Products are damaged by an external force (such as the broken of the surface, the deformation of the product shell, the broken of the USB port, etc.); or
- 4) Disassembling, repairing by a third party, refurbishment of the Products (such as downloading erroneous firmware) without the written authorization of ZWO; or
- 5) The product system is modified, or the maintenance notice is lost or changed; or
- 6) Product quality problem caused by installation not following the requirements or instructions for the Products; or
- 7) Physical damage or failure of the Products caused by the force majeure (such as strong vibration or extrusion such as flood, fire, earthquake, or thunder stroke); or
- 8) Damage caused by the improper User operation during the period of shooting or use, such as using without the equipment protection or direct shooting of the sun; or
- 9) No valid purchase invoice or warranty certificate; or
- 10) The Products are second-hand products.

Any quality problem with the accessories or other parts of the Products is not a condition for the return or change of the Products, and the User may solely request to replace the accessories with new ones, which shall be handled after verification by ZWO support team.