

STAR ADVENTURER GTi
USER'S MANUAL



Sky-Watcher®
Be amazed

www.skywatcher.com

©2021 Sky-Watcher. All rights reserved. Specifications subject to change without notice. 55-21001.

Sky-Watcher®
Be amazed

SKY-WATCHER® STAR ADVENTURER GTi

Foreword

As technology changes in the world, so does the way we do things. Here at Sky-Watcher® we recognize the changes and implement the new technologies into our products to improve the experience you have. Our products serve a purpose, and we intend to continue to create new and exciting ways to help you reach the stars and beyond. You'll be amazed with what is out there!

About the Mount

The Star Adventurer GTi is a portable, lightweight, and practical tracking mount that has the ability to both track the apparent movement of the stars as well as find celestial and deep space objects. The mount utilizes the SynScan GoTo system to find and track various astronomical objects.

The Star Adventurer GTi is equipped with a V-style mounting saddle and supports up to 11 pound payload capacity and is designed to work with AA batteries or 12v power supply. The Star Adventurer GTi also has Wi-Fi connectivity to truly go wireless allowing for a safe environment, avoid trip hazards, and potential snag issues associated with wires. The mount itself also supports full computer connectivity as well as autoguiding via ST-4 connection.

For Your Safety

To prevent damage to your Sky-Watcher product or injury to yourself or to others, read the following safety precautions entirely before using this equipment. Keep these safety instructions available to all users of the product.

By default, all mounts are shipped with the clutches unlocked to avoid any damage to the internal components during transit.

To prevent possible injury, pay special attention to all warnings before using this Sky-Watcher product. We also suggest reading through this guide before attempting to use or assemble the mount.

WARNING

- Do not look at the Sun through the polar scope. Viewing the Sun or other strong light sources through the polar scope could cause permanent eye damage.
- Do not use electronic equipment in the presence of flammable gas, as this could result in explosion or fire.
- Keep out of reach of children. Failure to do so could result in injury. Moreover, note that small parts constitute a choking hazard. Consult a physician immediately when a child swallows any part of this equipment.
- Do not disassemble. Touching the product's internal parts could result in injury and/or void the warranty. In the event of malfunction, remove the batteries and contact a Sky-Watcher authorized service center.

Notice

- Sky-Watcher reserves the right to change the specification of the hardware and software described in this manual at any time and without prior notice.
- Sky-Watcher cannot be held liable for any damage resulting from inappropriate use of this product.

STAR ADVENTURER GTi SPECIFICATION

Tracking mode	Astrophotography: EQ mode
Max. payload	5kg (11 pounds)
Wheel gear	Copper - Diameter 15.8mm
Worm gear	Aluminum alloy - Diameter 92mm
Motor drive	Miniature DC servo motor
Built-in accessory	Illuminated polar scope
Polar scope	Approximately 8.5° field of view
Working voltage	8x AA Battery: DC 9V ~ 12.6V External power supply: DC 12V
Duration of operation	Over 10 hours continuous tracking with Lithium Ion AA batteries at 20°C. (Battery life varies depending on load and battery quality/type)
Operational temperature	-10°C ~ 50°C
Dimensions	227mm x 227mm x 125mm - Mount Head
Weight	2.6kg (5.7 pounds)
Dovetail type	Standard Vixen dovetail mount (V Style)

WARRANTY & CUSTOMER SUPPORT

Warranty information differs from region to region. Contact your local dealer for the warranty in your region.

Warranty shall be void and of no force of effect in the event a covered product has been modified in design or function, or subjected to abuse, misuse, mishandling or unauthorized repair. Further, product malfunction or deterioration due to normal wear is not covered by this warranty. Sky-Watcher is not responsible for any user modifications to any products.

Sky-Watcher reserves the right to modify or discontinue, without prior notice to you, any model or style telescope.

For technical and customer support, you will need to contact your regional support team. Please refer to the Sky-Watcher website and check under "Global Distributer" for your specific region.

<http://www.skywatcher.com/where-to-buy/>

SNAP PORT AND CAMERA REMOTE

The Star Adventurer GTi is equipped with the ability to control most cameras that have a remote trigger port.

To connect to the SNAP port, you will need to purchase a shuttle release cable (sold separately). Connect the 2.5mm jack into port marked on fig. 8a.

Connect the other end of the cable to your camera's remote trigger port. Each camera will differ in the type of connectors that it utilizes. In some cases, an adapter from USB to 2.5mm shutter release converter is also required.

With the SynScan Pro app, you will have the option of camera control. Please refer to the SynScan Pro app manual for more details.

<https://www.skywatcher.com/download/manual/synscan-hand-control-and-synscan-app/>

Please note that not all cameras may support this feature.

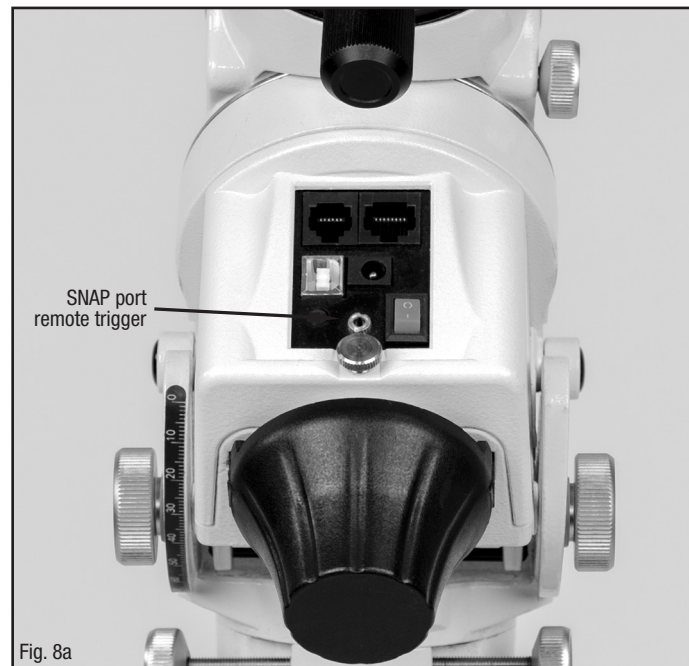

Fig. 8a

CARE AND MAINTENANCE

While your Star Adventurer GTi requires little to no maintenance, there are a few things to remember that will ensure the longevity of your product.

CARE AND CLEANING

Occasionally, dust and/or moisture may build up on the mount. Special care should be taken when cleaning any instrument so as not to damage the components. We recommend wiping the mount down with a dry lint-free cloth. For more stubborn dirt, a damp cloth can also be used.

Do not jam anything or insert any cleaning devices into any of the electronics ports on the Star Adventurer GTi. This may result in damage to the pins and/or connectors.

BATTERY COMPARTMENT

Never leave batteries stored inside of the battery compartments for extended periods of time. Doing so may result in batteries leaking causing corrosion. If you plan on not using the Star Adventurer GTi for extended periods of time, remove the batteries and store inside its original box or any protective packing to prevent dust, dirt and moisture damage to the unit.

Do not force batteries into the compartment tray. Doing so may result in damage to the compartment causing the mount to not power up. Always ensure that batteries are installed correctly by referencing the polarity position of each battery before turning on the unit. Do not install batteries of the wrong sizes.

GENERAL OPERATION

Always disengage the RA & DEC clutches before moving the mount manually. Never exceed the rated payload capacity stated. Failure will result in extreme stress to the motors causing damage.

Always cover the polar scope borehole with the provided polar cover when not doing a polar alignment. The borehole exposes this interior of the mount and small objects may fall in if care is not taken. Never insert any object down the polar scope borehole.

The Star Adventurer GTi contains no user serviceable parts. If you have any issues, please contact Technical Support.

WHAT'S IN THE BOX

STAR ADVENTURER GTi MOUNT & TRIPOD KIT

Ensure that all parts are at hand:

1. Light weight tripod
2. Counterweight (2.5kg - 5.5 pounds)
3. Counterweight collar
4. Counterweight shaft
5. Counterweight safety screw
6. Tripod spreader base
7. Azimuth screws
8. Dovetail locking screw
9. Polar scope cap
10. Tripod extension
11. Tripod extension thumb screws
12. Mount head

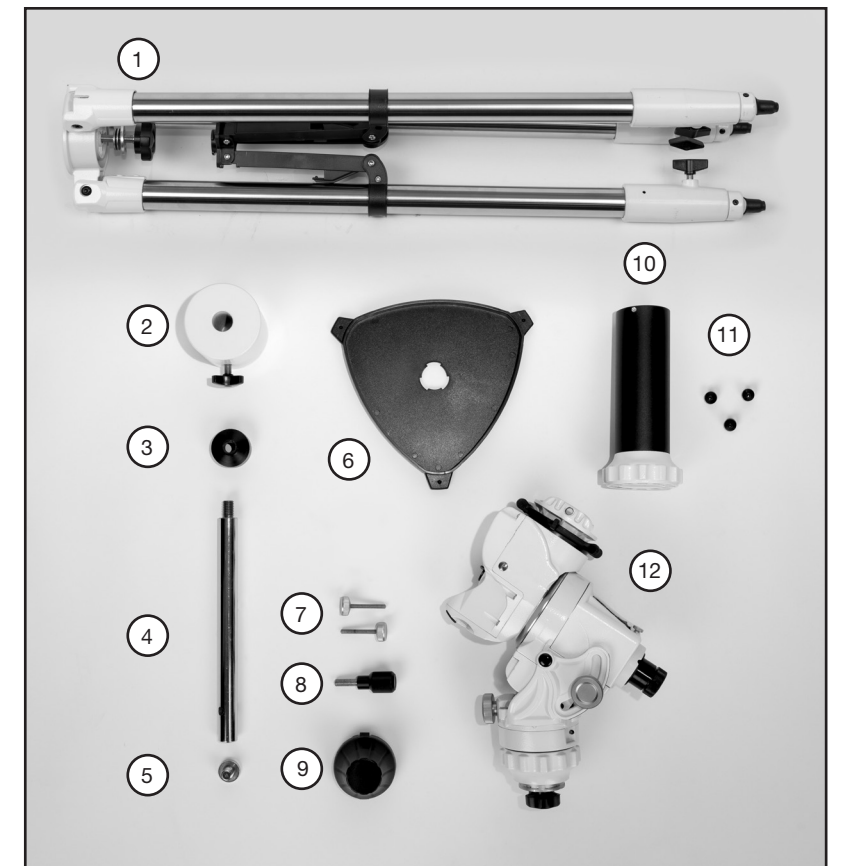

STAR ADVENTURER GTi MOUNT HEAD KIT

Ensure that all parts are at hand:

1. Counterweight collar
2. Counterweight shaft
3. Counterweight safety screw
4. Counterweight (2.5kg - 5.5 pounds)
5. Azimuth screws
6. Dovetail locking screw
7. Polar scope cap
8. Mount head

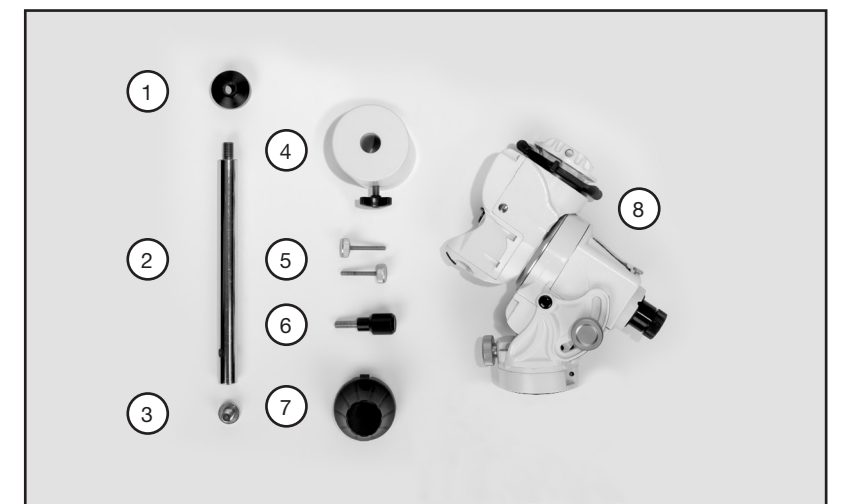

NOTE: Before you begin, please verify which kit you have before assembling the system. The Star Adventurer GTi comes in two versions, the mount head & tripod kit or the mount head only.

SETTING UP THE STAR ADVENTURER GTi

NOTE: Before you begin, please verify which kit you have before assembling the system. The Star Adventurer GTi comes in two versions, the mount head & tripod kit, or the mount head only.

Step 1

Start by opening the tripod and setting the desired height and attaching the spreader base. For stability purposes, we suggest extending the tripod legs out to their fullest length.



Step 2

Attach the mount to the tripod and fasten via the central bolt located underneath the top of the tripod base.



Step 3

Make sure that the mount head is secured to the tripod. The mount head should not rotate on the base of the tripod.

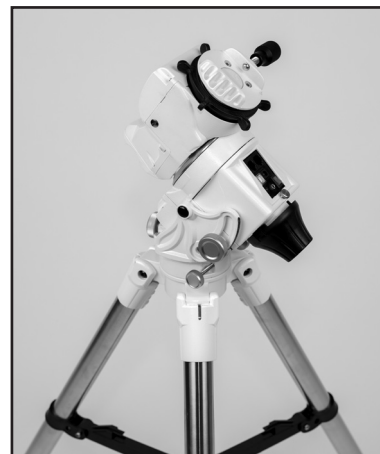

Step 4

Based on your location, roughly set the altitude by turning the knob below the counterweight borehole to raise or lower the mount head.

Attach the counterweight collar to the shaft, and then attach the shaft to the mount. Depending on your altitude, you can set the shaft for either high or low altitudes.

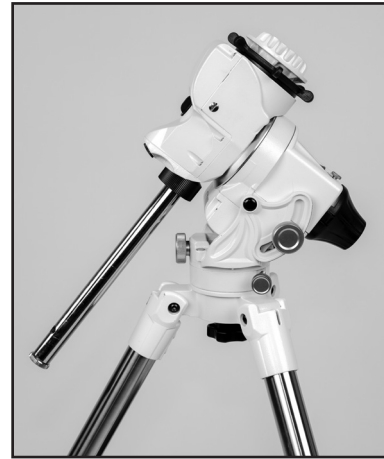

Step 5

Orient the tripod and mount to face "True North/South".

Magnetic north/south is a few degrees off from the celestial poles. Use a reference app to ensure that the mount is facing the correct direction.



Step 6

Disengage the clutch lock (black ring with thumb spokes) and orient the saddle to face left to right with the dovetail locking screw facing away from you.



NOTE: Before moving on, check to ensure that the mount head is firmly attached and that the system does not wiggle or rock back and forth. To ensure that the system is correctly attached, lift the mount head up to make sure that it does not come apart from the tripod.

GUIDING WITH THE STAR ADVENTURER GTi

Guiding is used on telescope mounts to remove any stray movements caused by misalignment on the polar axis as well as some level of worm gear movement that is not constant with a sidereal rate. To combat this, we employ the use of guiding to allow the user to do longer exposures without the need of manually adjusting the mount. The Star Adventurer GTi is equipped with an ST-4 port for on-camera guiding as well as direct over USB.

A guide scope and guide camera are required in order to do autoguiding (sold separately by your local telescope dealer).

Before we begin, make sure that you have the appropriate guiding software installed on your device.

Follow these steps in order to set up autoguiding for the mount.

Step 1

Start by installing the latest version of ASCOM.

<https://ascom-standards.org/>

Download the SynScan Pro app for Windows and the ASCOM drivers for the Star Adventurer GTi.

All software can be found at the following website:

<http://www.skywatcher.com/download/software/>

Next, install the ASCOM drivers (PC).

ASCOM Driver for SynScan Pro app Version.
ASCOM Driver for SynScan hand controller.
(Version numbers will change as and when new updates become available).

<http://www.skywatcher.com/download/software/ascom-driver/>

Install the SynScan Pro app (PC).

<http://www.skywatcher.com/download/software/synscan-app/>

Step 2

Connect your guide camera to your PC (refer to user manuals for connection on specific camera).
Connect the mount via USB to your PC using a USB 2.0 cable.

If you have an ST-4 port on the camera, connect the ST-4 cable to the camera and mount. ST-4 uses a 6P6C RJ12 data cable (sold separately). Connect the power to the mount and turn the Star Adventurer GTi on.

Step 3

Launch the SynScan Pro app.
Click on SETTINGS and then CONNECT SETTINGS.
Select SERIAL and choose the appropriate port (COM).
Click BACK and then CONNECT.
SynScan Pro will now be connected to your mount and is ready for use.

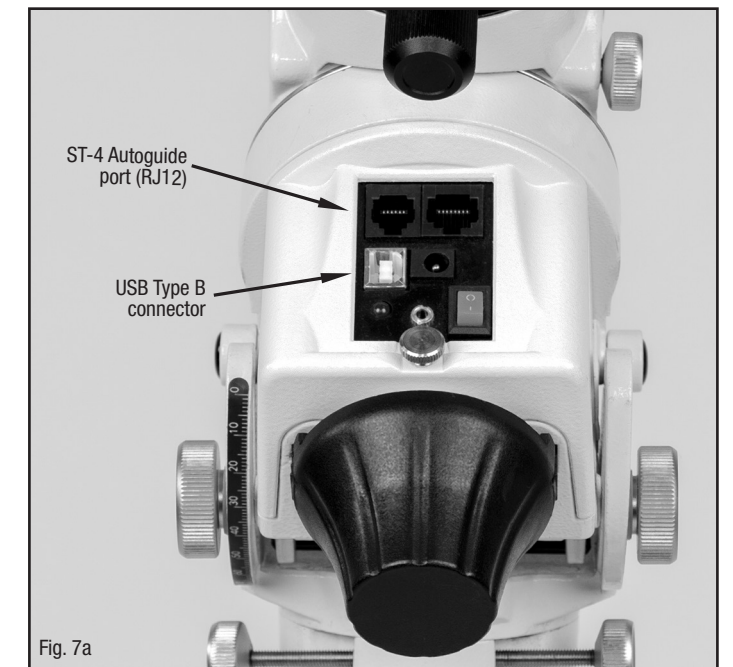

Fig. 7a

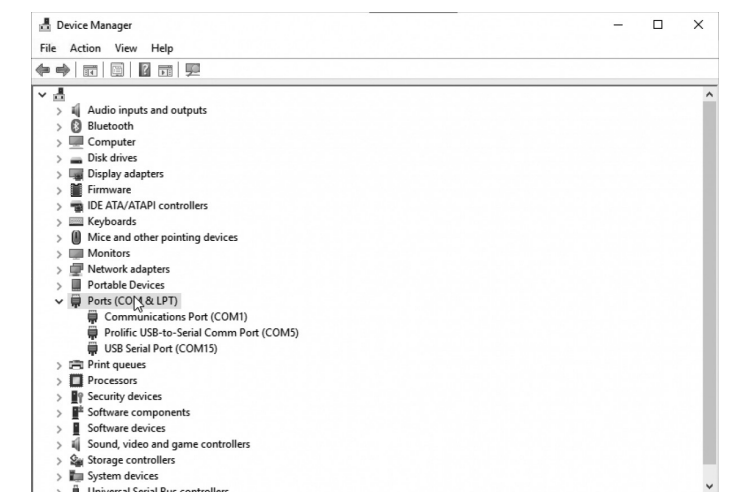

Fig. 7b

To find out which COM port the Star Adventurer GTi is using, open up DEVICE MANAGER in Windows found in the CONTROL PANEL. Look for Prolific USB-to-Serial Comm Port (Fig. 7b). If you have a yellow circular exclamation mark shows up next to the serial port, download and install the Prolific USB-to-Serial Device Driver.

Step 4

Open your guiding software and follow the instructions from your program on connecting to the mount. When selecting the mount type, make sure "SynScan App Driver" is selected. This will allow ASCOM direct communication to the SynScan Pro app.

For more information on the SynScan Pro app and ASCOM connection, refer to the SynScan Pro manual for more information:

<http://www.skywatcher.com/download/manual/synscan-hand-control-and-synscan-app/>

CONNECTING TO THE STAR ADVENTURER GTi

The Star Adventurer GTi features built in Wi-Fi and can connect in several ways. The following shows the different methods:

- Wi-Fi via smart device
- Wi-Fi via computer
- USB via computer (cable sold separately)
- SynScan hand controller (sold separately)

If you are using a smart device (Android or iOS), you need to download and install the SynScan Pro app. This can be found on the Apple Store or the Google Play Store. The app is free to download and is a requirement for connecting via Wi-Fi.

If connecting via a computer, the SynScan Pro app can be downloaded directly from our website:

<http://www.skywatcher.com/download/software/synscan-app/>

If connecting via the SynScan hand controller, you will need to purchase a hand controller from your preferred vendor.

Wi-Fi via Smart Device

Download the app and install it to your smart device.

Power ON the mount via the switch located on the Star Adventurer GTi.

Locate the Wi-Fi settings on your smart device. You will need to connect to the Wi-Fi signal that the Star Adventurer GTi is broadcasting.

The Wi-Fi name will have the following format:

SynScan_****

Once selected, your smart device will be tethered to the mount.

Open the SynScan Pro app and select "Connect".

Your device will display the SynScan device within range. Tap the device and the app will connect.

Wi-Fi via Computer

Download the SynScan app and save it to a location where you can find it.

Power ON the mount via the switch located on the Star Adventurer GTi.

Connect to the Wi-Fi network that the mount is broadcasting.

The Wi-Fi name will have the following format:

SynScan_****

Once selected, your smart device will be tethered to the mount.

Open the SynScan Pro app and select "Connect".

Your device will display the SynScan device within range. Click the device and the app will connect.

USB via Computer

Download the SynScan app and save it to a location where you can find it.

Plug the mount in via USB (Fig. 6a). Make sure that the device is turned OFF before plugging the USB connection in.

Power ON the mount via the switch located on the Star Adventurer GTi.

Open the SynScan Pro app and select "Connect".

Click the device and the app will connect.

Connecting via SynScan Hand Controller

Plug the RJ45 cable into the bottom of the hand controller port, and then connect to the mount (Fig. 6a).

Power ON the mount via the switch located on the Star Adventurer GTi.

You will be prompted by the hand controller on the screen to initiate the mount. (Refer to SynScan hand controller manual for more information).
<http://www.skywatcher.com/download/manual/synscan-hand-controller-and-synscan-app/>

NOTE: If you are using an existing Wi-Fi connection for the internet on a smart device, you will lose connection and your device will switch to cellular connection. You may also be required to set your device to remain connected regardless of connection to the internet. Please refer to your users manual on your specific device.

A detailed manual on the SynScan app can be downloaded from the Sky-Watcher support page:

<http://www.skywatcher.com/download/manual/>

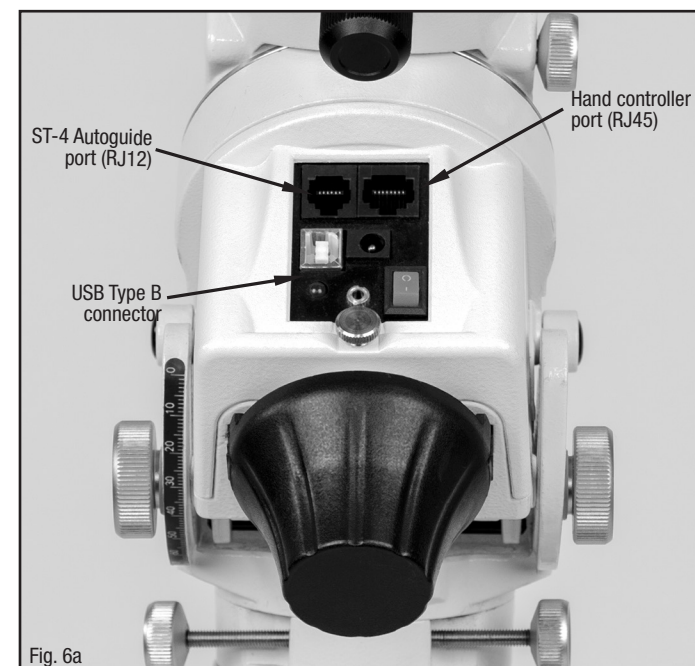

Step 7

Slide the counterweight onto the counterweight shaft at its lowest position.

Make sure that the clutches on the mount head are disengaged.

Make sure that counterweight safety screw is attached to the end of the counterweight shaft.



Step 8

Attach the telescope/camera to the mount via the dovetail clamp. Roughly balance the telescope/camera so it does not fall left or right.

Tighten the hand knob to hold down the telescope/camera.

Ensure that the telescope/camera is attached firmly before letting go.



NOTE: Never attach your telescope/camera to the mount before adding the counterweight.

It is important not to exceed the total weight payload of the mount. Doing so will result in damage to the equipment. Do not add any additional counterweight to the shaft as this will overload the mount.

By orienting the saddle left to right (sideways), this prevents the attached device from sliding out if the clamp is not securely fastened.

The mount is capable of handling both low and high latitudes. Ensure that the correct counterweight bore hole is used.

The reference images will help identify where the counterweight shaft should be position. When setting for lower altitudes, remove the counterweight shaft cap on the front of the mount (Fig. 1a).

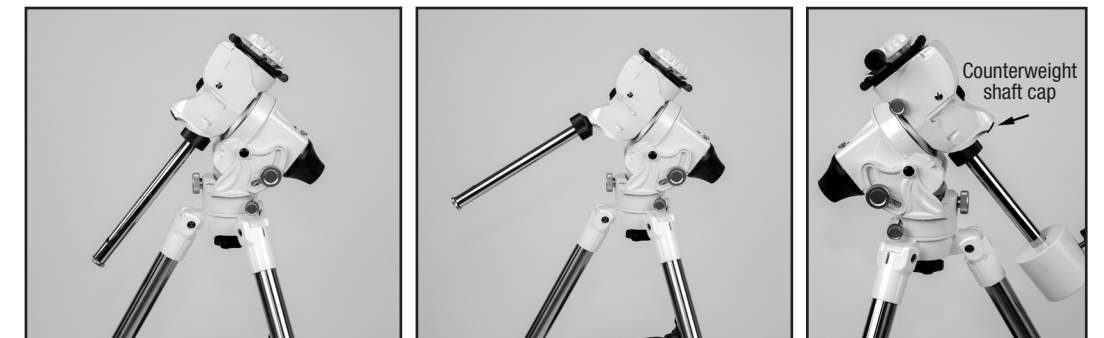

Fig. 1a

ATTACHING THIRD-PARTY TRIPODS

The Star Adventurer GTi can be attached to most photographic tripod with a 3/8"-16 central bolt and a flat base, large enough for the mount head to sit on for stability. The third-party tripod must be capable of handling a minimum of 11lbs. It is also ideal to use tripods that do not have a height adjustable central column since these are not designed to carry heavy weights. If you need to increase the height, Sky-Watcher recommends using the optional tripod extension.

Sky-Watcher does NOT recommend the use of tilt heads, video pan heads or any type of ball head. Doing so will result in the mount head tipping or falling off since most tripod mount heads cannot support the weight of the mount and telescope.

Before attaching a third-party tripod, please make sure that the tripod is able to handle the weight of the Star Adventurer GTi including the counterweight and telescope plus accessories.

Step 1

Ensure that the tripod is level with the ground and the legs are spread all the way out.

Some tripods may have spread locks, make sure that these are engaged before putting any load onto the tripod.



Step 3

Check to make sure that the Star Adventurer GTi is secured to the tripod.

Simply lifting the Star Adventurer GTi up and making sure that the mount head does not wobble, will ensure that everything is attached.

Once attached, the counterweight shaft and counterweight can be attached to the mount head.



Step 2

Attach the mount head to the tripod using the 3/8"-16 bolt. This bolt will connect to the underside of the Star Adventurer GTi.

Ensure the counterweight hole, is over one of the legs of the tripod.

This will allow the counterweight and shaft to not come into contact with the tripod during operation.



Note

Do not transport the Star Adventurer GTi full assembled or attached to any tripod. Doing so will result in damage to the mount head and/or the tripod.

In the event of the 3/8"-16 bolt being too long, do NOT use washers or spacers to fill the gap.

Sky-Watcher does not recommend using 1/4"-20 bolts or smaller tripods that are not equipped with a 3/8"-16 bolt as standard.

If you are unsure that your tripod is capable of handling the Star Adventurer GTi, do not attempt to attach the mount head. Sky-Watcher suggests contacting your local authorized dealer. For a list of dealers, please visit <https://www.skywatcher.com/where-to-buy/>

POWERING THE STAR ADVENTURER GTi

The Star Adventurer GTi can be powered using eight AA batteries or via a 12V DC power adapter (sold separately).

If powering the mount via AA batteries, place them into the mount by removing the side covers (Fig 5b). To access the battery compartment, unscrew the thumb screw located on the back of the mount above the polar scope (Fig 5a).

Make sure that the batteries are oriented in the correct direction where the springs are in contact with the negative side of the batteries. Check the battery holder for indication marks if you are unsure.

Do not mix old and new batteries together or from different brands. Sky-Watcher recommends the use of AA batteries. Similarly, never use batteries that are damaged or mix full and partially rechargeable batteries. This may result in damage to the electrical components of the mount.

Always remove batteries from the compartment when the mount is being stored for extended periods of time.

The Star Adventurer GTi can also be powered using a 12V DC source. You can utilize an AC/DC power transformer if you want to plug into a wall outlet. Make sure that the power supply used has an output of 12V at 2 amps and 2.1mm center pin positive - 5.5mm length.

You can also connect the Star Adventurer GTi to a battery pack using a DC cigarette connector to a 2.1mm center pin positive - 5.5mm length. Ensure that the battery pack provides a 12 volt current. Sky-Watcher does not recommend connecting the mount directly to a car battery without an inline fuse with a maximum rate of 5 amps. Doing so may damage the electronic components inside the mount.

WARNING: Do not connect to a 24/48 volt power source. Never connect the mount to a gas generator either via AC or DC. Gas generators (not including inverter generators) are considered unsafe for electronic devices. This is due to the constant fluctuating voltage supplied by a generator.

If you are unsure about any power source or power adapter, Sky-Watcher suggests using AA batteries.

AA batteries typically last approximately 36 hours when tracking. Constant slewing of the mount will reduce time. Larger capacity batteries will yield longer times.

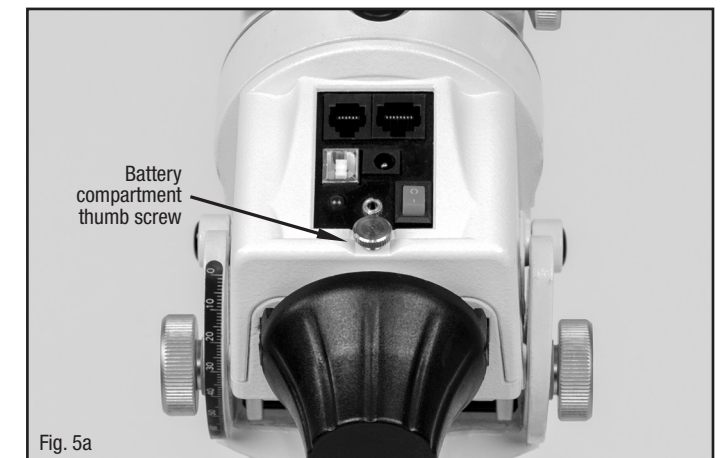

Fig. 5a

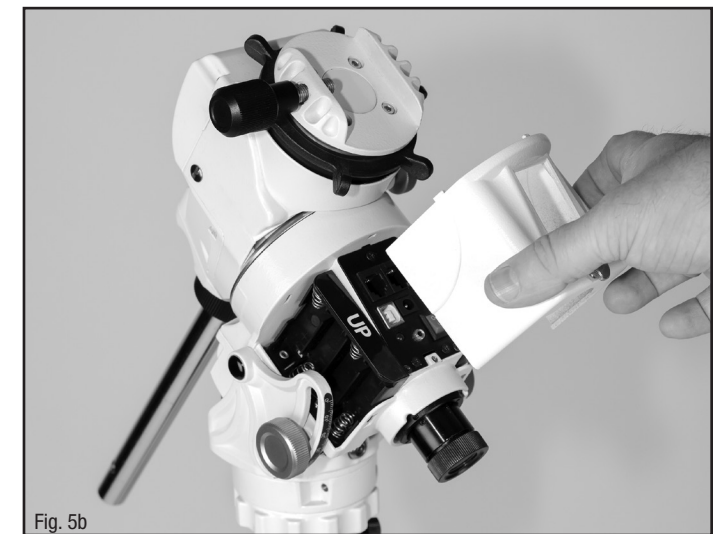
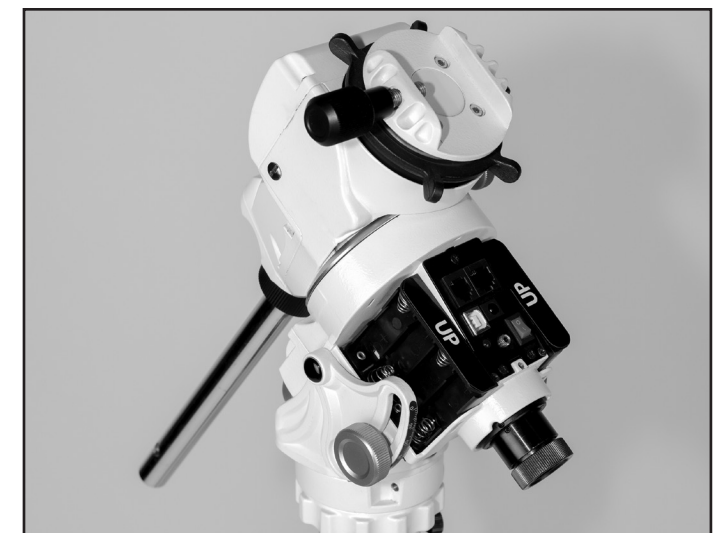

Fig. 5b



Step 1

Make sure that the mount is level with the ground. A small bubble level is located above the altitude control knob on the side (Fig. 4a). Remove the polar cover on the front of the mount.

Before starting the polar alignment, ensure that the mount is oriented towards True North/South. This is generally a few degrees off from the Magnetic North/South.

Step 2

Adjust the altitude of your mount according to your location.

You will need to know the latitude and longitude of your current location in order to determine the altitude of where to adjust your mount.

The number you need to find is the North/South number (latitude). Assuming you are in the northern hemisphere, your location is indicated with a number followed by the letter N.

The first grouping of numbers would indicate where to set the altitude of the mount. Example, if you are in Los Angeles, California, your latitude would be 34°N. On the Star Adventurer GTI, there is an indication marker with a scale (Fig. 4b).

Southern hemisphere users can also set the altitude in the same manner. A negative number is assumed as positive on the scale. Example, if you are in Sydney, Australia, your latitude would be -34°S. Set the altitude to 34°.

Rotate the altitude control knob which is found on the front of the mount (Fig. 4a).

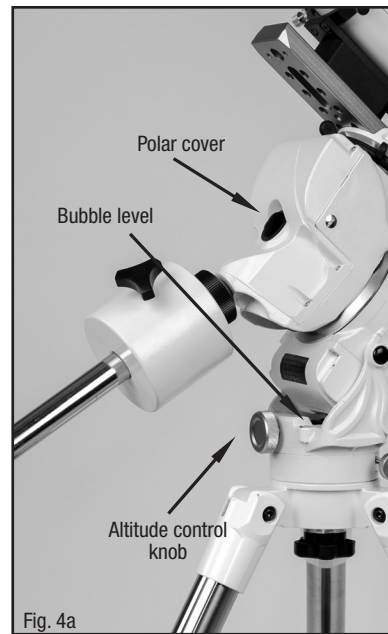

Fig. 4a

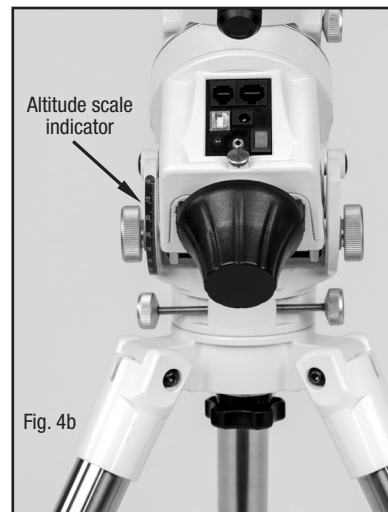

Fig. 4b

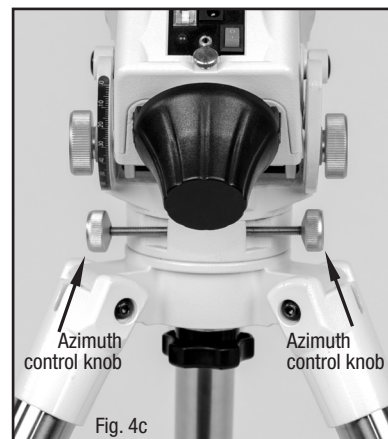

Fig. 4c

Step 3

Set the "hour angle" of the polar scope so "0" is pointed straight up. To do so, rotate the mount on the RA axis. Make sure that the DEC axis is in the left to right position.

Within the SynScan Pro app, select "Advanced" and then "polar scope".

If using a smart device, the app will automatically calculate and insert your time and location, if not, you will be prompted to insert for location.

When the location is acquired by your device, the polar reticle will display the location of where Polaris needs to be (Octans if in southern hemisphere). This is shown as a circle within the reticles out three circles. Adjusting the altitude and azimuth screws, carefully place Polaris into the correct location.

Southern hemisphere users will need to rotate the RA axis for the Octans to be positioned in the correct orientation before aligning the four stars on the reticle of the polar scope.

Once you have determined the locations of the required star(s), use the altitude knob to make adjustments in the up/down axis on the polar scope.

Using the azimuth control knobs (Fig. 4c), adjust the mounts left/right axis to move the star(s) into the correct positions on the polar scope.

When finished, move the mount to the home position (Fig. 4d).

NOTE: The Star Adventurer GTI is equipped with an illuminated reticle which is activated via the SynScan App on a smart device (refer to the SynScan app manual). Remember to turn OFF the illuminator when completed to conserve power.

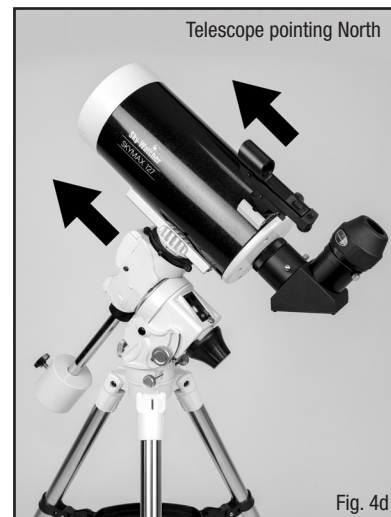
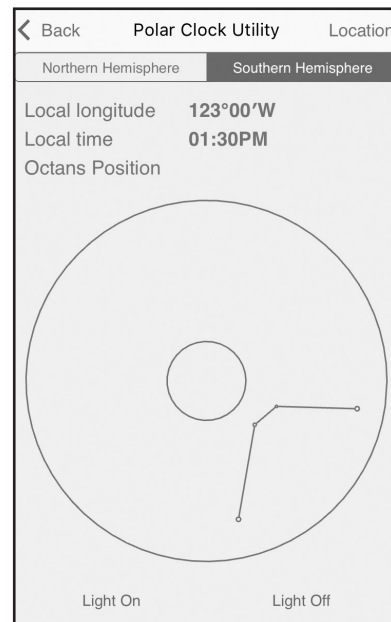
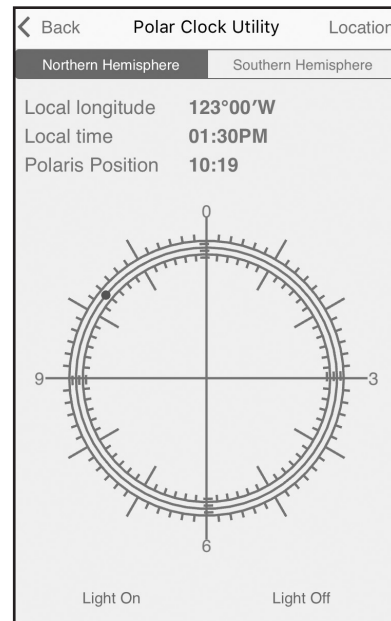

Fig. 4d

OPTIONAL TRIPOD EXTENSION

NOTE: Before you begin, please verify which kit you have before assembling the system. The Star Adventurer GTI comes in two versions, the mount head & tripod kit, or the mount head only. If you have the mount head only kit and would like the tripod and tripod extension, they can be purchased separately from your local dealer.

The Star Adventurer GTI can be equipped with an optional column extension that raises the height of the mount head. This is normally required for longer telescopes to clear the tripod legs.

The column extension has been designed to be complete disassembled for transportation. We advise when transporting the mount to detach the column extension and store it separately from the mount head and tripod. To prevent loss and damage of the thumb screws, do not leave them on the column extension.

Parts list:

1. Star Adventurer GTI mount head
2. Column lock
3. Tripod extension
4. Thumb screws

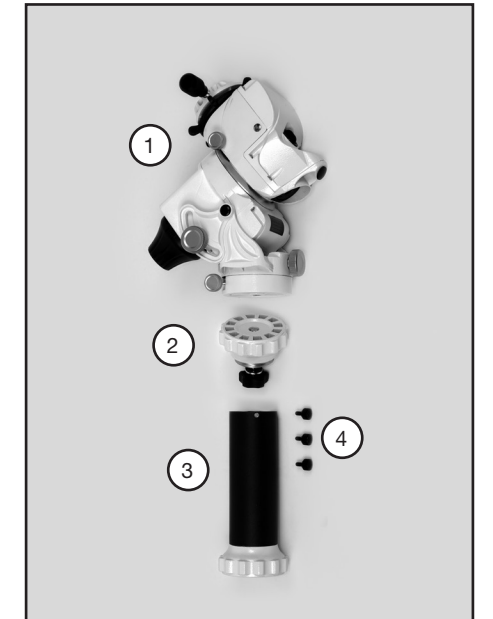

Step 1

Attach the mount column lock onto the bottom of the mount head and tighten the bolt.



Step 2

Screw the tripod extension column onto the tripod and lock in place using the hand screw located under the tripod head.



Step 3

Stand the tripod upright and place the mount head with the column lock into the tripod extension and tighten the thumb screws to hold the mount head in place.



Note

Do not transport the Star Adventurer GTI full assembled. While the column lock can be left on the mount head during transportation, damage can occur if the entire mount and tripod are not disassembled.

Ensure that the tripod is fully extended while using the tripod extension.

BALANCING THE STAR ADVENTURER GTi

Remember to always install the counterweight before you begin.

The optical system needs to be balanced for both Right Ascension and Declination, (RA+DEC) in order for the mount to function as intended. This is achieved by moving the optical system within the saddle as well as the counterweight along the shaft. Before you begin, make sure that everything is fastened securely to the mount, and that the mount is secured to the tripod and does not present any tipping hazards from uneven ground or loose soil.

Step 1

Set the counterweight to the bottom of the shaft.

Slide the optical system left or right to ensure that the system is balanced by loosening the dovetail locking screw.

The optical system should not fall to either side and remain stationary. Make necessary adjustments until balanced, remember to tighten dovetail lock screw when completed.



Step 2

Disengage the RA clutch and orient the optical system so it too is parallel to the ground.

If the optical system pitches forward or backwards, the DEC is not balanced and will need to be adjusted.

Once you have corrected any balance issues on DEC, you may proceed with sliding the counterweight along the shaft.

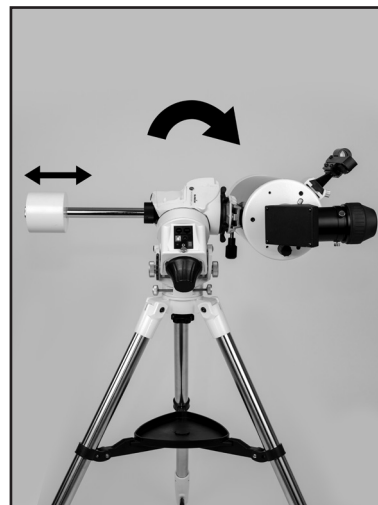

Step 3

Flip the mount over to the other side by rotating counterclockwise. Check to make sure that both RA and DEC axis are balanced. Adjust if required.

Remember, when adjusting the optical system, always return the mount to its upright position, with the saddle oriented left to right before attempting to move the optical system to avoid any mishaps.



Once balancing is completed, the mount should be able to be placed in any position, with the clutches disengaged, and not have the system move or fall in any direction.

All accessories must be attached when balancing the optical systems. If you are using a refractor telescope, set the focus to be as close to focus as possible. A general rule is to extend the focuser out to 3/4 its length. On camera lenses that extend out, set it to the 2/3 of the focal length. This will ensure that if the length of optical system changes from focusing or zooming, the Star Adventurer GTi will not be overly unbalanced.

Always have a hold on the system with your hand in case it moves during any part of the balancing phase.

TIPS: When the counterweight shaft is parallel to the ground and the optical system pitches forward, too much weight is located at the front. The same applies if it pitches backwards, meaning there is too much weight in the back. Move the optical system accordingly to ensure that it does not move when oriented in this position. You will need to return the mount to its upright position before doing so to avoid any mishaps.

Once you are done with balancing the system, return the mount to its upright position, ensuring that the optical system is back in its left to right orientation (Fig. 2a).

The DEC clutch is located at the top of the mount under the saddle. Rotating counterclockwise will loosen the clutch (Fig. 2b).

The RA clutch is located on the side of the mount on the right hand side when standing behind the mount (Fig. 2b).

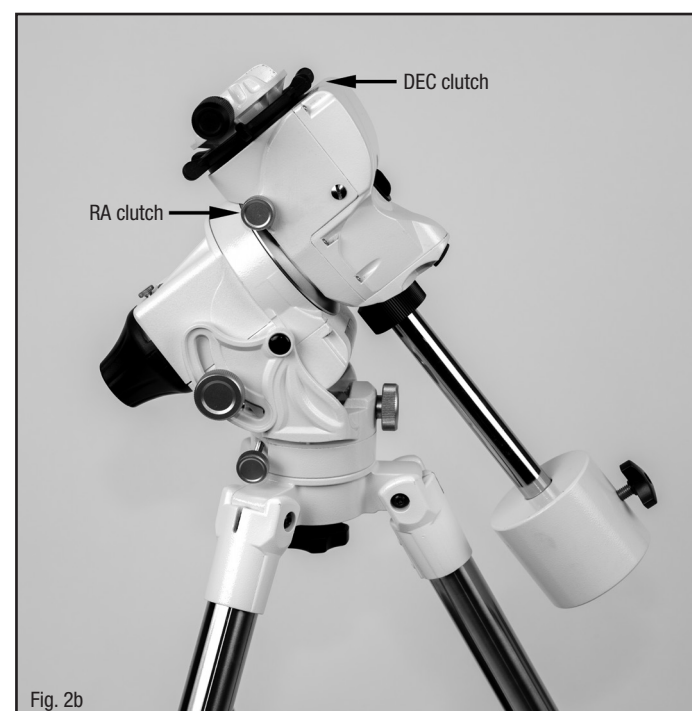

POLAR ALIGNING THE STAR ADVENTURER GTi

When doing long exposure photography of the night sky, stars are often referenced as moving across the sky. They appear to circle around the celestial poles of the Earth (Fig. 3a). In order to counteract this apparent movement, the Star Adventurer GTi can be set to compensate for this movement, by rotating the camera in the direction opposite to that of the Earth's spin. The result is, the celestial objects appearing in the field of view of your camera do not move allowing for a picture with a long exposure time to be possible (Fig. 3b). In order to achieve this, a polar alignment (PA) of the Star Adventurer GTi is required.

The Star Adventurer GTi comes equipped with a polar scope located along the polar axis of the mount and is embedded into the system. To view through the polar scope, remove the protective cover from the back of the mount by pinching down the tabs on the side of the casing (Fig. 3c). The polar scope also has an illumination reticle for ease of use.

For observing in the Northern Hemisphere: find Polaris (the brightest star near the North Celestial Pole) in the polar scope by adjusting the angle of the equatorial wedge. Use the SynScan Pro App to find the corresponding orientation of Polaris in the polar scope by simply entering the date, time, longitude and latitude of your observing location. The polar scope utility can be found under "Utility" and then "Advanced". Move Polaris to that corresponding position in the polar scope by using the fine-tuning movements of the equatorial wedge (Fig. 3d). If you cannot acquire the application tool to find the orientation of Polaris, refer to the "The Orientation of Polaris in Polar Scope" (Fig. 3d).

For observing in the Southern Hemisphere: locate in the polar scope the four dim stars (around Magnitude 5 to 6) which form the pattern "Octans" (see drawing in the polar scope as Fig. 3e). Align the orientation of the "Octans" drawing to the four stars. Then move the four stars to the four small circles of the "Octans" drawing by using the horizontal adjustment knob to fine-tune the equatorial wedge or by moving the tilt-head of your tripod.



Fig. 3a



Fig. 3b

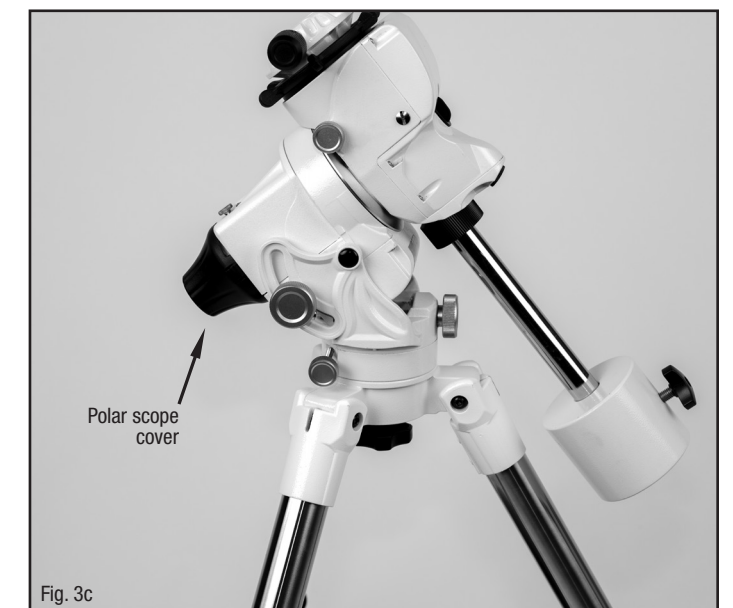

Fig. 3c

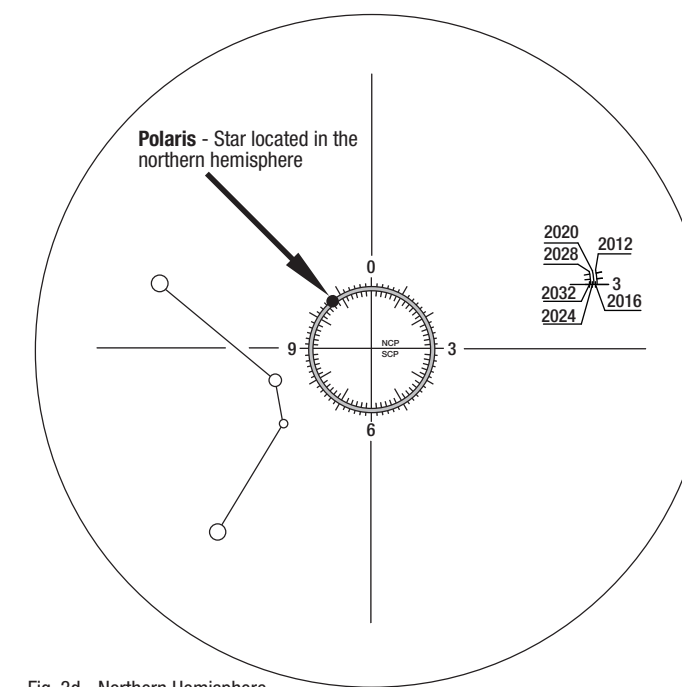

Fig. 3d - Northern Hemisphere

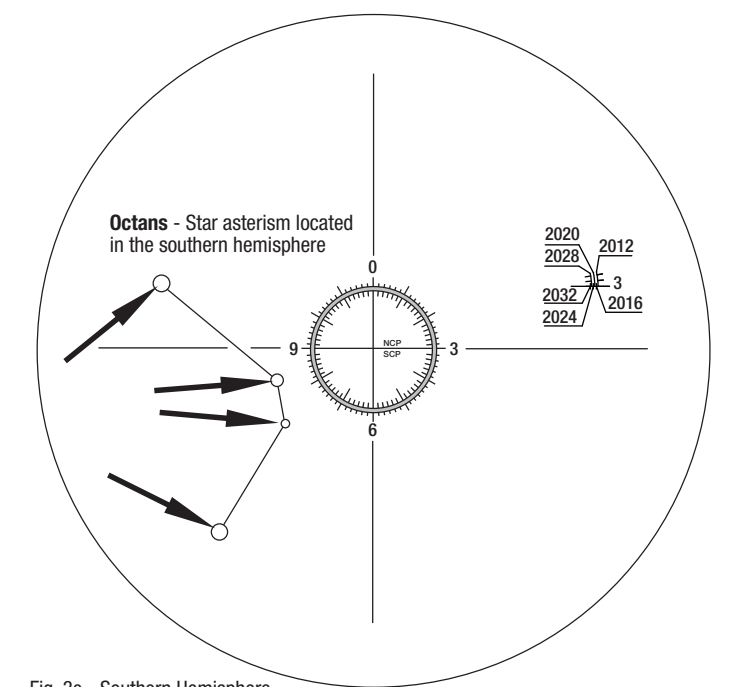

Fig. 3e - Southern Hemisphere